

HFR™

313997R

EN

Hydraulic, Plural-Component, Fixed-Ratio Proportioner.
For pouring and dispensing sealants and adhesives and polyurethane foam.

For professional use only. Not for use in explosive atmospheres.



Important Safety Instructions

Read all warnings and instructions in this manual. Save these instructions.

See page 4 for model information and maximum working pressure.

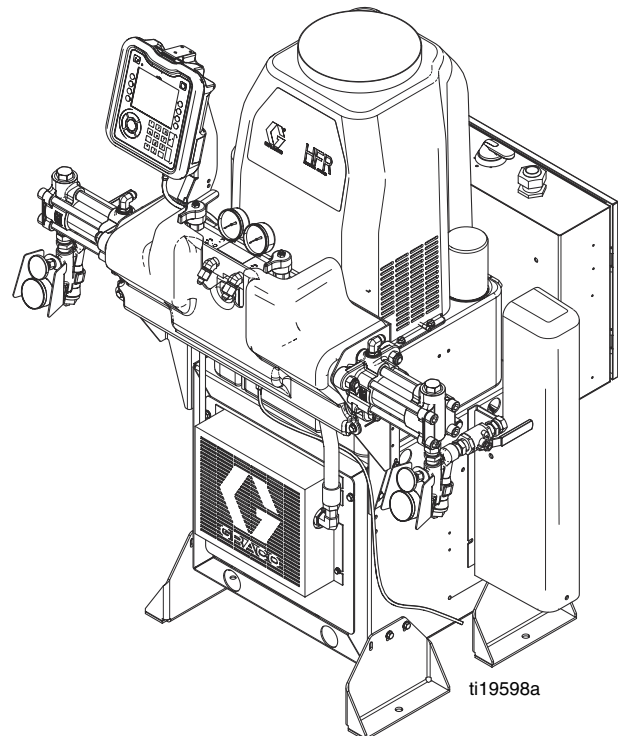

Contents

Related Manuals	3	Maintenance	53
Models	4	ADM - Battery Replacement and Screen Cleaning	
Product Configurator	5	54	
Whip Hose Bundles	7	MCM and TCM - Clean Heat Sink Fins	54
Individual B (Blue) Heated Whip Hose	7	Install Upgrade Tokens	55
Individual A (Red) Heated Whip Hose	7	Fluid Inlet Strainer Screen	56
B (Blue) Individual	8	IsoGuard Select [®] System	57
A (Red) Individual	9	Troubleshooting	58
Hose Bundling Accessories	9	Light Tower (Optional)	58
Applicator	10	Common Problems	58
B (Blue) Applicator Orifice	11	ADM Troubleshooting	61
Iso A (Red) Applicator Orifice	13	Motor Control Module	62
AC Power Pack with S-Head/L-Head Hoses, Optional Boom	14	Fluid Control Module	64
Dispense Valve Interface Kit	14	Temperature Control Module	65
Flow Meters	14	Appendix A - ADM Icons Overview	66
Pump Feed Kits	15	Setup Screen Icons	66
B (Blue) and A (Red) Feed Tanks	16	Run Screen Icons	67
Warnings	18	Appendix B - ADM Setup Screens Overview	68
Important Two-Component Material Information	20	Appendix C - ADM Run Screens Overview	82
Isocyanate Conditions	20	Appendix D - ADM Error Codes	88
Material Self-ignition	20	Appendix E - System Events	100
Keep Components A (Red) and B (Blue) Separate	20	Appendix F - USB Operation	102
Moisture Sensitivity of Isocyanates	21	Overview	102
Foam Resins with 245 fa Blowing Agents	21	USB Options	102
Changing Materials	21	Download Log Files	102
A (Red) and B (Blue) Components	21	Log Files, Folder Structure	103
Typical Installation	23	Transfer System Settings	105
Component Identification	24	Update Custom Language	106
Hydraulic Power Pack	27	Technical Data	108
Motor Control Module (MCM)	28	Motor Control Module Technical Data	109
Advanced Display Module (ADM)	30	Dimensions	110
Fluid Control Module (FCM)	33	Graco Standard Warranty	112
Temperature Control Module (Heated HFR Only)	34	Graco Information	112
Dispense Valves Overview	37		
Setup	38		
Vacuum De-gas	44		
Vacuum De-gas and Vacuum Manual Refill ...	45		
Advanced Display Module (ADM) Operation	46		
Startup	47		
Shutdown	50		
Pressure Relief Procedure	51		
Flushing	52		

Related Manuals

Manuals are available at www.graco.com.
Component manuals in English:

System Manuals	
313998	HFR Repair-Parts
Power Distribution Box Manual	
3A0239	Power Distribution Boxes Instructions-Parts
Pumpline Manuals	
3A0019	Z-Series Chemical Pumps Instructions-Parts
3A0020	HFR Hydraulic Actuator Instructions-Parts
Feed System Manuals	
3A0238	Dispense Head Hydraulic Power Pack Instructions-Parts
3A0235	Feed Supply Kits Instructions-Parts
3A0395	Stainless Steel Tank Feed Systems Instructions-Parts
3A1299	Carbon Steel Tank Feed Systems Instructions-Parts
3A0237	Heated Hoses and Applicator Kits, Instructions-Parts
Dispense Valve Manuals	
313872	EP™ Gun
313536	GX-16, Operation
312185	MD2 Valve, Instructions-Parts
312752	S-Head Operation-Parts
312753	L-Head Operation-Parts
309550	Fusion® AP Gun
309856	Fusion MP Gun
312666	Fusion CS Gun

Accessory Manuals	
3A1149	HFR Discrete Gateway Module Kits Manual
312864	HFR Communications Gateway Module Instructions-Parts
3A1657	HFR Flow Meter Kits Instructions-Parts
3A1244	Graco Control Architecture™ Module Programming Manual
3A2890	Mobile Pallet with Casters Kit Manual

Models

See **Product Configurator** on page 5 for detailed product configuration information.

System	Full Load Peak Amps Per Phase*	Voltage (phase)	System Watts†	Primary Heater Watts (per heater)	Max Flow Rate◆** lb/min (kg/min)	Approximate Output per Cycle (A+B)** gal. (liter)	Hydraulic Pressure Ratio**	Maximum Fluid Working Pressure ‡ psi (MPa, bar)
HFR, Non-Heated	55 A	230V (1)	12,650	--	50 (22.7)	0.084 (0.318)	1.9:1	3000 (20.7, 207)
	29 A	230V (3)	11,340					
	55 A ★	400V (3)	12,650					
HFR, Heated	116 A	230V (1)	26,680	6,000	50 (22.7)	0.084 (0.318)	1.9:1	3000 (20.7, 207)
	73 A	230V (3)	28,600					
	75 A ★	400V (3)	28,600					

* Full load amps with all devices operating at maximum capabilities. Fuse requirements at various flow rates and mix chamber sizes may be less.

** Values are dependent on installed pump size. Values shown are for largest available pump size.

† 210 ft (64 m) maximum heated hose length, including whip hose.

◆ Flow rate is independent of frequency 50/60 Hz.

★  approved.

‡ The maximum fluid working pressure for the base machine without hoses is 3000 psi (20.7 MPa, 207 bar). If hoses rated at less than 3000 psi are installed, the system maximum fluid working pressure becomes the rating of the hoses. If 2000 psi hoses were purchased and installed by Graco, the working pressure for the machine is already setup for the lower 2000 psi (13.8 MPa, 138 bar) working pressure by Graco. If the machine was purchased without hoses and aftermarket hoses rated at or above 3000 psi are to be installed, see instruction manual 313998 for the procedure to setup the machine for higher rated hoses. The change in working pressure is made by changing a rotary switch setting in the Motor Control Module. The minimum pressure rating for hoses is 2000 psi. Do not install hoses with a pressure rating lower than 2000 psi.

Product Configurator

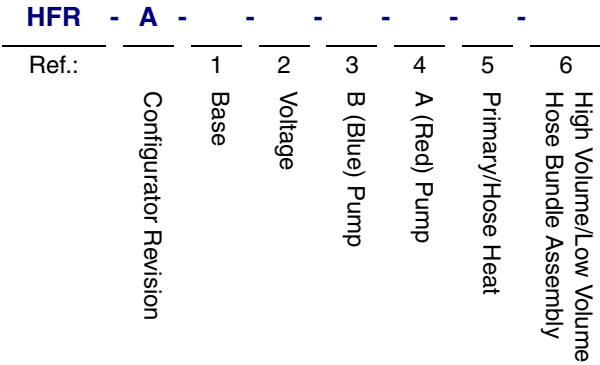

An example of the product configurator would be the following configurator code.

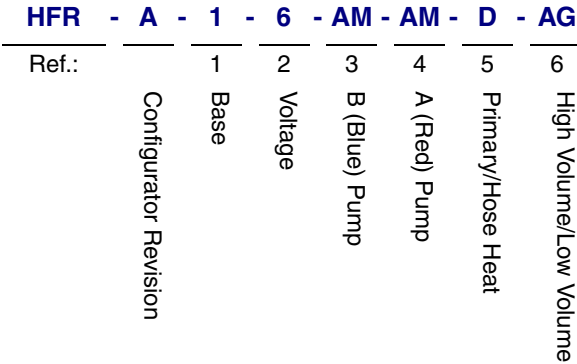

The following part number fields apply for the HFR part numbering configurator fields.

Ref. 1	Part	Base Unit
1		HFR Base Unit, Carbon Steel
2		HFR Base Unit, Stainless Steel
Ref. 2	Part	Voltage
1		230V, 1 phase; No Heat
2		230V, 1 phase; Maximum of Two 6 kW Primary Heater and One Zone of Hose Heat
3		230V, 3 phase; No Heat
4		230V, 3 phase; Maximum of Two 6 kW Primary Heaters and Two Zones of Hose Heat
5		400V, 3 phase; No heat
6		400V, 3 phase; Maximum of Two 6 kW Primary Heaters and Two Zones of Hose Heat

Ref. 3	Part	B (Blue) Pump †
AA	L010S1	10 cc Stainless Steel
AB	L015S1	15 cc Stainless Steel
AC	L020S1	20 cc Stainless Steel
AD	L025S1	25 cc Stainless Steel
AE	L030S1	30 cc Stainless Steel
AF	L040S1	40 cc Stainless Steel
AG	L050S1	50 cc Stainless Steel
AH	L060S1	60 cc Stainless Steel
AJ	L080S1	80 cc Stainless Steel
AK	L100S1	100 cc Stainless Steel
AL	L120S1	120 cc Stainless Steel
AM	L160S1	160 cc Stainless Steel
AN	L005S1	5 cc Stainless Steel
AP	L086S1	86 cc Stainless Steel
AQ	L065S1	65 cc Stainless Steel
Ref. 4	Part	A (Red) Pump †
Code, Part, and Description for Ref. 4 are the same as Ref. 3		

Ref. 5	Part	Primary/Hose Heat
A		No Heat
B		A (Red) and B (Blue) Primary Heaters
C		A (Red) and B (Blue) Primary Heaters, One Zone of Hose Heat
D		A (Red) and B (Blue) Primary Heaters, A (Red) and B (Blue) Hose Heat
E		A (Red) and B (Blue) Hose Heat, Carbon Steel
F		A (Red) and B (Blue) Hose Heat, Stainless Steel
G		B (Blue) Primary Heaters, B (Blue) Hose Heat
Ref. 6	Part	B (Blue) Applicator Hose or High Volume/ Low Volume Hose Bundle Assembly
NN	--	No Hose
AA	24D108	Dual Hose, 2:1, 1/4 x 3/8, 5 ft, Stainless Steel, 3500 psi
AB	24D109	Dual Hose, 2:1, 1/4 x 3/8, 10 ft, Stainless Steel, 3500 psi
AC	24D110	Dual Hose, 2:1, 1/4 x 3/8, 25 ft, Stainless Steel, 3500 psi
AD	24D111	Dual Hose, 2:1, 1/4 x 3/8, 50 ft, Stainless Steel, 3500 psi
AE	24D112	Dual Hose, 1:1, 3/8 x 3/8, 5 ft, Stainless Steel, 3500 psi
AF	24D113	Dual Hose, 1:1, 3/8 x 3/8, 10 ft, Stainless Steel, 3500 psi
AG	24D114	Dual Hose, 1:1, 3/8 x 3/8, 25 ft, Stainless Steel, 3500 psi
AH	24D115	Dual Hose, 1:1, 3/8 x 3/8, 50 ft, Stainless Steel, 3500 psi
BA	24D116	Dual Hose, 2:1, 1/4 x 3/8, 5 ft, Stainless Steel, 3500 psi
BB	24D117	Dual Hose, 2:1, 1/4 x 3/8, 10 ft, Carbon Steel, 3500 psi
BC	24D118	Dual Hose, 2:1, 1/4 x 3/8, 25 ft, Carbon Steel, 3500 psi
BD	24D119	Dual Hose, 2:1, 1/4 x 3/8, 50 ft, Carbon Steel, 3500 psi
BE	24D120	Dual Hose, 1:1, 3/8 x 3/8, 5 ft, Carbon Steel, 3500 psi
BF	24D121	Dual Hose, 1:1, 3/8 x 3/8, 10 ft, Carbon Steel, 3500 psi
BG	24D122	Dual Hose, 1:1, 3/8 x 3/8, 25 ft, Carbon Steel, 3500 psi
BH	24D123	Dual Hose, 1:1, 3/8 x 3/8, 50 ft, Carbon Steel, 3500 psi
CA	24E968	Single Hose, 1:1, 1/4 x 1/4, 10 ft, Carbon Steel, 2000 psi
CB	24E963	Single Hose, 1:1, 1/4 x 1/4, 25 ft, Carbon Steel, 2000 psi
CC	24E964	Single Hose, 1:1, 1/4 x 1/4, 50 ft, Carbon Steel, 2000 psi
CD	24D124	Single Hose, 2:1, 1/4 x 3/8, 25 ft, Carbon Steel, 2000 psi
CE	24D125	Single Hose, 2:1, 1/4 x 3/8, 50 ft, Carbon Steel, 2000 psi

CF	24E969	Single Hose, 1:1, 3/8 x 3/8, 10 ft, Carbon Steel, 2000 psi
CG	24D126	Single Hose, 1:1, 3/8 x 3/8, 25 ft, Carbon Steel, 2000 psi
CH	24D127	Single Hose, 1:1, 3/8 x 3/8, 50 ft, Carbon Steel, 2000 psi
CJ	24E965	Single Hose, 1:1, 1/2 x 1/2, 50 ft, Carbon Steel, 2000 psi
CK	24E966	Single Hose, 1:1, 1/4 x 1/4, 50 ft, Carbon Steel, 3500 psi
CL	24D129	Single Hose, 2:1, 1/4 x 3/8, 50 ft, Carbon Steel, 3500 psi
CM	24D131	Single Hose, 1:1, 3/8 x 3/8, 50 ft, Carbon Steel, 3500 psi
CN	24E967	Single Hose, 1:1, 1/2 x 1/2, 50 ft, Carbon Steel, 3500 psi

† Pump size listed is the combined volume dispensed in one extending stroke and one retracting stroke.

Whip Hose Bundles

Part	Description
24H076	10 ft (3 m) long, 1/4 in. (6 mm) ID, Carbon Steel, Single Zone
24H077	10 ft (3 m) long, 3/8 in. (10 mm) ID, Carbon Steel, Single Zone
24H078	10 ft (3 m) long, 1/4 in. (6 mm) ID, Carbon Steel, Dual Zone
24H079	10 ft (3 m) long, 3/8 in. (10 mm) ID, Carbon Steel, Dual Zone
24H080	10 ft (3 m) long, 1/4 in. (6 mm) ID, Stainless Steel, Single Zone
24H081	10 ft (3 m) long, 3/8 in. (10 mm) ID, Stainless Steel, Single Zone
24H082	10 ft (3 m) long, 1/4 in. (6 mm) ID, Stainless Steel, Dual Zone
24H083	10 ft (3 m) long, 3/8 in. (10 mm) ID, Stainless Steel, Dual Zone

Individual B (Blue) Heated Whip Hose

Part	Description
24E950	10 ft (3 m) long, 1/4 in. (6 mm) ID, Carbon Steel, Single Zone, 3500 psi
24E952	10 ft (3 m) long, 3/8 in. (10 mm) ID, Carbon Steel, Single Zone, 3500 psi
24H086	10 ft (3 m) long, 1/4 in. (6 mm) ID, Carbon Steel, Dual Zone, 3500 psi
24H088	10 ft (3 m) long, 3/8 in. (10 mm) ID, Carbon Steel, Dual Zone, 3500 psi
24H090	10 ft (3 m) long, 1/4 in. (6 mm) ID, Stainless Steel, Single Zone, 3500 psi
24H092	10 ft (3 m) long, 3/8 in. (10 mm) ID, Stainless Steel, Single Zone, 3500 psi
24H094	10 ft (3 m) long, 1/4 in. (6 mm) ID, Stainless Steel, Dual Zone, 3500 psi
24H096	10 ft (3 m) long, 3/8 in. (10 mm) ID, Stainless Steel, Dual Zone, 3500 psi

24H225	5 ft (1.5 m) long, 1/4 in. (6 mm) ID, Carbon Steel, Single Zone, 3500 psi
24H227	5 ft (1.5 m) long, 3/8 in. (10 mm) ID, Carbon Steel, Single Zone, 3500 psi
24H229	5 ft (1.5 m) long, 1/4 in. (6 mm) ID, Carbon Steel, Dual Zone, 3500 psi
24H231	5 ft (1.5 m) long, 3/8 in. (10 mm) ID, Carbon Steel, Dual Zone, 3500 psi
24H233	5 ft (1.5 m) long, 1/4 in. (6 mm) ID, Stainless Steel, Single Zone, 3500 psi
24H235	5 ft (1.5 m) long, 3/8 in. (10 mm) ID, Stainless Steel, Single Zone, 3500 psi
24H237	5 ft (1.5 m) long, 1/4 in. (6 mm) ID, Stainless Steel, Dual Zone, 3500 psi
24H239	5 ft (1.5 m) long, 3/8 in. (10 mm) ID, Stainless Steel, Dual Zone, 3500 psi

Individual A (Red) Heated Whip Hose

Part	Description
24E949	10 ft (3 m) long, 1/4 in. (6 mm) ID, Carbon Steel, Single Zone, 3500 psi
24E951	10 ft (3 m) long, 3/8 in. (10 mm) ID, Carbon Steel, Single Zone, 3500 psi
24H085	10 ft (3 m) long, 1/4 in. (6 mm) ID, Carbon Steel, Dual Zone, 3500 psi
24H087	10 ft (3 m) long, 3/8 in. (10 mm) ID, Carbon Steel, Dual Zone, 3500 psi
24H089	10 ft (3 m) long, 1/4 in. (6 mm) ID, Stainless Steel, Single Zone, 3500 psi
24H091	10 ft (3 m) long, 3/8 in. (10 mm) ID, Stainless Steel, Single Zone, 3500 psi
24H093	10 ft (3 m) long, 1/4 in. (6 mm) ID, Stainless Steel, Dual Zone, 3500 psi
24H095	10 ft (3 m) long, 3/8 in. (10 mm) ID, Stainless Steel, Dual Zone, 3500 psi
24H224	5 ft (1.5 m) long, 1/4 in. (6 mm) ID, Carbon Steel, Single Zone, 3500 psi
24H226	5 ft (1.5 m) long, 3/8 in. (10 mm) ID, Carbon Steel, Single Zone, 3500 psi
24H228	5 ft (1.5 m) long, 1/4 in. (6 mm) ID, Carbon Steel, Dual Zone, 3500 psi
24H230	5 ft (1.5 m) long, 3/8 in. (10 mm) ID, Carbon Steel, Dual Zone, 3500 psi
24H232	5 ft (1.5 m) long, 1/4 in. (6 mm) ID, Stainless Steel, Single Zone, 3500 psi
24H234	5 ft (1.5 m) long, 3/8 in. (10 mm) ID, Stainless Steel, Single Zone, 3500 psi
24H236	5 ft (1.5 m) long, 1/4 in. (6 mm) ID, Stainless Steel, Dual Zone, 3500 psi
24H238	5 ft (1.5 m) long, 3/8 in. (10 mm) ID, Stainless Steel, Dual Zone, 3500 psi

Hoses

Part	Description
24D111	Dual Hose, 2:1, 1/4 x 3/8, 50 ft, Stainless Steel, 3500 psi
24D115	Dual Hose, 1:1, 3/8 x 3/8, 50 ft, Stainless Steel, 3500 psi
24D119	Dual Hose, 2:1, 1/4 x 3/8, 50 ft, Carbon Steel, 3500 psi
24D123	Dual Hose, 1:1, 3/8 x 3/8, 50 ft, Carbon Steel, 3500 psi
24E964	Single Hose, 1:1, 1/4 x 1/4, 50 ft, Carbon Steel, 2000 psi
24D125	Single Hose, 2:1, 1/4 x 3/8, 50 ft, Carbon Steel, 2000 psi
24D127	Single Hose, 1:1, 3/8 x 3/8, 50 ft, Carbon Steel, 2000 psi
24E965	Single Hose, 1:1, 1/2 x 1/2, 50 ft, Carbon Steel, 2000 psi
24E966	Single Hose, 1:1, 1/4 x 1/4, 50 ft, Carbon Steel, 3500 psi
24D129	Single Hose, 2:1, 1/4 x 3/8, 50 ft, Carbon Steel, 3500 psi
24D131	Single Hose, 1:1, 3/8 x 3/8, 50 ft, Carbon Steel, 3500 psi
24E967	Single Hose, 1:1, 1/2 x 1/2, 50 ft, Carbon Steel, 3500 psi

B (Blue) Individual

Part	Description
24E902	Heated Hose, 5 ft, 1/4, Carbon Steel, 3500 psi
24E904	Heated Hose, 10 ft, 1/4, Carbon Steel, 3500 psi
24E906	Heated Hose, 25 ft, 1/4, Carbon Steel, 3500 psi
24E908	Heated Hose, 50 ft, 1/4, Carbon Steel, 3500 psi
24E910	Heated Hose, 5 ft, 3/8, Carbon Steel, 3500 psi
24E912	Heated Hose, 10 ft, 3/8, Carbon Steel, 3500 psi
24E914	Heated Hose, 25 ft, 3/8, Carbon Steel, 3500 psi
24E916	Heated Hose, 50 ft, 3/8, Carbon Steel, 3500 psi
24E918	Heated Hose, 5 ft, 1/2, Carbon Steel, 3500 psi
24E920	Heated Hose, 10 ft, 1/2, Carbon Steel, 3500 psi
24E922	Heated Hose, 25 ft, 1/2, Carbon Steel, 3500 psi
24E924	Heated Hose, 50 ft, 1/2, Carbon Steel, 3500 psi
24E926	Heated Hose, 5 ft, 1/4, Stainless Steel, 3500 psi
24E928	Heated Hose, 10 ft, 1/4, Stainless Steel, 3500 psi
24E930	Heated Hose, 25 ft, 1/4, Stainless Steel, 3500 psi
24E932	Heated Hose, 50 ft, 1/4, Stainless Steel, 3500 psi
24E934	Heated Hose, 5 ft, 3/8, Stainless Steel, 3500 psi
24E936	Heated Hose, 10 ft, 3/8, Stainless Steel, 3500 psi
24E938	Heated Hose, 25 ft, 3/8, Stainless Steel, 3500 psi
24E940	Heated Hose, 50 ft, 3/8, Stainless Steel, 3500 psi
24E942	Heated Hose, 5 ft, 1/2, Stainless Steel, 3500 psi
24E944	Heated Hose, 10 ft, 1/2, Stainless Steel, 3500 psi
24E946	Heated Hose, 25 ft, 1/2, Stainless Steel, 3500 psi
24E948	Heated Hose, 50 ft, 1/2, Stainless Steel, 3500 psi
262174	Unheated Hose, 5 ft, 1/4, Carbon Steel, 3500 psi
262176	Unheated Hose, 10 ft, 1/4, Carbon Steel, 3500 psi
262178	Unheated Hose, 25 ft, 1/4, Carbon Steel, 3500 psi
262180	Unheated Hose, 50 ft, 1/4, Carbon Steel, 3500 psi
262182	Unheated Hose, 5 ft, 3/8, Carbon Steel, 3500 psi
262184	Unheated Hose, 10 ft, 3/8, Carbon Steel, 3500 psi
262186	Unheated Hose, 25 ft, 3/8, Carbon Steel, 3500 psi
262188	Unheated Hose, 50 ft, 3/8, Carbon Steel, 3500 psi
262190	Unheated Hose, 5 ft, 1/2, Carbon Steel, 3500 psi
262192	Unheated Hose, 10 ft, 1/2, Carbon Steel, 3500 psi
262194	Unheated Hose, 25 ft, 1/2, Carbon Steel, 3500 psi
262196	Unheated Hose, 50 ft, 1/2, Carbon Steel, 3500 psi
262237	Unheated Hose, 5 ft, 1/4, Stainless Steel, 3500 psi

262239	Unheated Hose, 10 ft, 1/4, Stainless Steel, 3500 psi
262241	Unheated Hose, 25 ft, 1/4, Stainless Steel, 3500 psi
262243	Unheated Hose, 50 ft, 1/4, Stainless Steel, 3500 psi
262245	Unheated Hose, 5 ft, 3/8, Stainless Steel, 3500 psi
262247	Unheated Hose, 10 ft, 3/8, Stainless Steel, 3500 psi
262249	Unheated Hose, 25 ft, 3/8, Stainless Steel, 3500 psi
262251	Unheated Hose, 50 ft, 3/8, Stainless Steel, 3500 psi
262253	Unheated Hose, 5 ft, 3/8, Stainless Steel, 3500 psi
262255	Unheated Hose, 10 ft, 3/8, Stainless Steel, 3500 psi
262257	Unheated Hose, 25 ft, 3/8, Stainless Steel, 3500 psi
262259	Unheated Hose, 50 ft, 3/8, Stainless Steel, 3500 psi

A (Red) Individual

Part	Description
24E901	Heated Hose, 5 ft, 1/4, Carbon Steel, 3500 psi
24E903	Heated Hose, 10 ft, 1/4, Carbon Steel, 3500 psi
24E905	Heated Hose, 25 ft, 1/4, Carbon Steel, 3500 psi
24E907	Heated Hose, 50 ft, 1/4, Carbon Steel, 3500 psi
24E909	Heated Hose, 5 ft, 3/8, Carbon Steel, 3500 psi
24E911	Heated Hose, 10 ft, 3/8, Carbon Steel, 3500 psi
24E913	Heated Hose, 25 ft, 3/8, Carbon Steel, 3500 psi
24E915	Heated Hose, 50 ft, 3/8, Carbon Steel, 3500 psi
24E917	Heated Hose, 5 ft, 1/2, Carbon Steel, 3500 psi
24E919	Heated Hose, 10 ft, 1/2, Carbon Steel, 3500 psi
24E921	Heated Hose, 25 ft, 1/2, Carbon Steel, 3500 psi
24E923	Heated Hose, 50 ft, 1/2, Carbon Steel, 3500 psi
24E925	Heated Hose, 5 ft, 1/4, Stainless Steel, 3500 psi
24E927	Heated Hose, 10 ft, 1/4, Stainless Steel, 3500 psi
24E929	Heated Hose, 25 ft, 1/4, Stainless Steel, 3500 psi
24E931	Heated Hose, 50 ft, 1/4, Stainless Steel, 3500 psi
24E933	Heated Hose, 5 ft, 3/8, Stainless Steel, 3500 psi
24E935	Heated Hose, 10 ft, 3/8, Stainless Steel, 3500 psi
24E937	Heated Hose, 25 ft, 3/8, Stainless Steel, 3500 psi
24E939	Heated Hose, 50 ft, 3/8, Stainless Steel, 3500 psi
24E941	Heated Hose, 5 ft, 1/2, Stainless Steel, 3500 psi
24E943	Heated Hose, 10 ft, 1/2, Stainless Steel, 3500 psi
24E945	Heated Hose, 25 ft, 1/2, Stainless Steel, 3500 psi
24E947	Heated Hose, 50 ft, 1/2, Stainless Steel, 3500 psi

262173	Unheated Hose, 5 ft, 1/4, Carbon Steel, 3500 psi
262175	Unheated Hose, 10 ft, 1/4, Carbon Steel, 3500 psi
262177	Unheated Hose, 25 ft, 1/4, Carbon Steel, 3500 psi
262179	Unheated Hose, 50 ft, 1/4, Carbon Steel, 3500 psi
262181	Unheated Hose, 5 ft, 3/8, Carbon Steel, 3500 psi
262183	Unheated Hose, 10 ft, 3/8, Carbon Steel, 3500 psi
262185	Unheated Hose, 25 ft, 3/8, Carbon Steel, 3500 psi
262187	Unheated Hose, 50 ft, 3/8, Carbon Steel, 3500 psi
262189	Unheated Hose, 5 ft, 1/2, Carbon Steel, 3500 psi
262191	Unheated Hose, 10 ft, 1/2, Carbon Steel, 3500 psi
262193	Unheated Hose, 25 ft, 1/2, Carbon Steel, 3500 psi
262195	Unheated Hose, 50 ft, 1/2, Carbon Steel, 3500 psi
262236	Unheated Hose, 5 ft, 1/4, Stainless Steel, 3500 psi
262238	Unheated Hose, 10 ft, 1/4, Stainless Steel, 3500 psi
262240	Unheated Hose, 25 ft, 1/4, Stainless Steel, 3500 psi
262242	Unheated Hose, 50 ft, 1/4, Stainless Steel, 3500 psi
262244	Unheated Hose, 5 ft, 3/8, Stainless Steel, 3500 psi
262246	Unheated Hose, 10 ft, 3/8, Stainless Steel, 3500 psi
262248	Unheated Hose, 25 ft, 3/8, Stainless Steel, 3500 psi
262250	Unheated Hose, 50 ft, 3/8, Stainless Steel, 3500 psi
262252	Unheated Hose, 5 ft, 1/2, Stainless Steel, 3500 psi
262254	Unheated Hose, 10 ft, 1/2, Stainless Steel, 3500 psi
262256	Unheated Hose, 25 ft, 1/2, Stainless Steel, 3500 psi
262258	Unheated Hose, 50 ft, 1/2, Stainless Steel, 3500 psi

Hose Bundling Accessories

Part	Description
24E953	Air Hose, 5 ft
15B280	Air Hose, 10 ft
15C624	Air Hose, 25 ft
15B295	Air Hose, 50 ft

24E900	Signal Cable, 5 pin, Male/Female, 2.0 meter
24E899	Signal Cable, 5 pin, Male/Female, 4.0 meter
24E898	Signal Cable, 5 pin, Male/Female, 8.5 meter
24E897	Signal Cable, 5 pin, Male/Female, 16.0 meter
24E896	Fluid Temperature Sensor Cable, 4 pin, Male/Female, 2.0 meter
24E895	Fluid Temperature Sensor Cable, 4 pin, Male/Female, 3.0 meter
24E894	Fluid Temperature Sensor Cable, 4 pin, Male/Female, 8.0 meter
24E893	Fluid Temperature Sensor Cable, 4 pin, Male/Female, 15.7 meter
24E954	Scuff Guard, 1.75 in. (44 mm), 200 ft (61 m) Roll
24E961	Scuff Guard, 1.75 in. (44 mm), 200 ft (61 m) Roll
261821	Wire Connector, 6AWG (4.11 mm)
24E955	Hose Lacing, 1500 ft (457.2 m) Roll
15B679	Hose Safety Label

Applicator

Part	Description
24A084	L-Head 6/10 With Calibration Orifice
24A085	L-Head 10/14 With Calibration Orifice
24A086	L-Head 13/20 With Calibration Orifice
24A090	S-Head 6-625 With Calibration Orifice
24A092	S-Head 6-500 L/S With Calibration Orifice
24A093	S-Head 6-625 L/S With Calibration Orifice
24J187	GX-16, 24:1, Straight, Machine Mount
24K233	GX-16, 24:1, Left, Machine Mount
24K234	GX-16, No Orifice, Left, Machine Mount
24E876	GX-16, No Orifice, Straight, Machine Mount
24E877	GX-16, 24:1, Right, Machine Mount
24E878	GX-16, No Orifice, Right, Machine Mount
CS00RD	Fusion CS, 1:1 Only, 0.029
CS01RD	Fusion CS, 1:1 Only, 0.042
CS02RD	Fusion CS, 1:1 Only, 0.052
246100	Fusion AP, 1:1 Only, 0.029
247007	Fusion MP, 1:1 Only, 0.029
246101	Fusion AP, 1:1 Only, 0.042
247019	Fusion MP, 1:1 Only, 0.047
246102	Fusion AP, 1:1 Only, 0.052
247025	Fusion MP, 1:1 Only, 0.057
24D500	Applicator, MD2, 1:1, Soft, Carbon Steel
24D501	Applicator, MD2, 1:1, Soft, Carbon Steel, Electric
24D502	Applicator, MD2, 1:1, Soft, Carbon Steel, Lever
24D503	Applicator, MD2, 1:1, Soft, Stainless Steel
24D504	Applicator, MD2, 1:1, Soft, Stainless Steel, Electric
24D505	Applicator, MD2, 1:1, Soft, Stainless Steel, Lever
24D509	Applicator, MD2, 1:1, Hard, Carbon Steel
24D510	Applicator, MD2, 1:1, Hard, Carbon Steel, Electric
24D511	Applicator, MD2, 1:1, Hard, Carbon Steel, Lever
24D512	Applicator, MD2, 1:1, Hard, Carbon Steel, Pneumatic
24D513	Applicator, MD2, 1:1, Hard, Stainless Steel
24D514	Applicator, MD2, 1:1, Hard, Stainless Steel, Electric
24D515	Applicator, MD2, 1:1, Hard, Stainless Steel, Lever
24D516	Applicator, MD2, 1:1, Hard, Stainless Steel, Pneumatic
24D521	Applicator, MD2, 10:1, Soft, Carbon Steel
24D522	Applicator, MD2, 10:1, Soft, Carbon Steel, Electric
24D523	Applicator, MD2, 10:1, Soft, Carbon Steel, Lever
24D524	Applicator, MD2, 10:1, Soft, Stainless Steel
24D525	Applicator, MD2, 10:1, Soft, Stainless Steel, Electric

24D526	Applicator, MD2, 10:1, Soft, Stainless Steel, Lever
24D530	Applicator, MD2, 10:1, Hard, Carbon Steel
24D531	Applicator, MD2, 10:1, Hard, Carbon Steel, Electric
24D532	Applicator, MD2, 10:1, Hard, Carbon Steel, Lever
24D533	Applicator, MD2, 10:1, Hard, Carbon Steel, Pneumatic
24D534	Applicator, MD2, 10:1, Hard, Stainless Steel
24D535	Applicator, MD2, 10:1, Hard, Stainless Steel, Electric
24D536	Applicator, MD2, 10:1, Hard, Stainless Steel, Lever
24D537	Applicator, MD2, 10:1, Hard, Stainless Steel, Pneumatic
24E505	MD2 Orifice Adapter Kit
257999	EP Pour Gun, Pistol Grip, 1/4 in. Purge Rod
24C932	EP Pour Gun, Machine mount, 1/4 in. Purge Rod
24C933	EP Pour Gun, Pistol Grip, 3/8 in. Purge Rod
24C934	EP Pour Gun, Machine Mount, 3/8 in. Purge Rod
LC0058	Mixer Kit, (10) 3/8 in. x 24 Element with Shroud
LC0059	Mixer Kit, (10) 3/8 in. x 36 Element with Shroud
LC0060	Mixer Kit, (10) 3/8 in. Combo with Shroud
LC0295	Mixer Kit, (10) 1/2 in. x 24 Element with Shroud
LC0296	Mixer Kit, (10) 1/2 in. x 36 Element with Shroud
LC0079	Mixer Pack, (50) 3/8 in. x 24 Element
LC0080	Mixer Pack, (50) 3/8 in. x 24 Element
LC0081	Mixer Pack, (50) 3/8 in. Combo Element
LC0086	Mixer Pack, (250) 3/8 in. x 24 Element
LC0087	Mixer Pack, (250) 3/8 in. x 36 Element
LC0088	Mixer Pack, (250) 3/8 in. Combo Element

B (Blue) Applicator Orifice

S-Head and L-Head

Description	Part	For Use With Applicator:
Calibrate	24A036	S-Head Only
0.25	24A037	S-Head Only
0.35	24A038	S-Head Only
0.50	24A039	S-Head Only
0.60	24A040	S-Head Only
0.70	24A041	S-Head Only
0.80	24A042	S-Head Only
0.90	24A043	S-Head Only
1.00	24A044	S-Head Only
1.10	24A045	S-Head Only
1.20	24A046	S-Head Only
1.30	24A047	S-Head Only
1.40	24A050	S-Head Only
1.50	24A051	S-Head Only

1.60	24A052	S-Head Only
1.70	24A053	S-Head Only
1.80	24A054	S-Head Only
1.90	24A055	S-Head Only
2.00	24A056	S-Head Only
2.50	24A057	S-Head Only
3.00	24A058	S-Head Only
3.50	24A059	S-Head Only
4.00	24A060	S-Head Only
4.20	24A061	S-Head Only
4.50	24A062	S-Head Only
5.00	24A063	S-Head Only
5.50	24A064	S-Head Only
6.00	24A065	S-Head Only
6.50	24A066	S-Head Only
7.00	24A067	S-Head Only
Calibrate	M0934A-4	L-Head Only
0.25	247761	L-Head Only
0.45	247762	L-Head Only
0.5	247763	L-Head Only
0.75	247764	L-Head Only
0.8	247765	L-Head Only
0.85	247766	L-Head Only
1	247767	L-Head Only
1.1	247811	L-Head Only
1.2	247848	L-Head Only
1.25	248858	L-Head Only
1.3	247859	L-Head Only
1.4	247860	L-Head Only
1.5	247861	L-Head Only
1.6	247862	L-Head Only
1.65	247863	L-Head Only
1.7	247864	L-Head Only
1.75	247865	L-Head Only
1.8	247866	L-Head Only
1.9	247867	L-Head Only
2	247868	L-Head Only
2.4	247869	L-Head Only
3.2	247870	L-Head Only
3.6	247871	L-Head Only
4.2	247872	L-Head Only
5	247873	L-Head Only
5.6	247874	L-Head Only

GX-16

Description	Part
257701	0.011 in. Orifice
257702	0.013 in. Orifice
257703	0.016 in. Orifice
257704	0.018 in. Orifice
257705	0.020 in. Orifice
257706	0.022 in. Orifice
257707	0.023 in. Orifice
257708	0.024 in. Orifice

Product Configurator

257709	0.025 in. Orifice
257710	0.026 in. Orifice
257711	0.028 in. Orifice
257712	0.029 in. Orifice
257713	0.032 in. Orifice
257714	0.035 in. Orifice
257715	0.036 in. Orifice
257716	0.038 in. Orifice
257717	0.039 in. Orifice
257718	0.040 in. Orifice
257719	0.042 in. Orifice
257720	0.043 in. Orifice
257721	0.044 in. Orifice
257722	0.049 in. Orifice
257723	0.052 in. Orifice
257724	0.061 in. Orifice
24K682	0.085 in. Orifice

EP™ Gun

Description	Part	For Use With Applicator:
Orifice Kit	24E250	EP 250, 6 Blue, 6 Red
0.51 mm Poly Orifice	24C751	EP 250 Poly Side Orifice, Std
0.79 mm Poly Orifice	24C752	EP 250 Poly Side Orifice, Std
1.19 mm Poly Orifice	24C753	EP 250 Poly Side Orifice, Std
1.52 mm Poly Orifice	24C754	EP 250 Poly Side Orifice, Std
1.70mm Poly Orifice	24C755	EP 250 Poly Side Orifice, Std
2.18 mm Poly Orifice	24C756	EP 250 Poly Side Orifice, Std
0.41 mm Poly Orifice	24C805	EP 250 Poly Side Orifice
0.61 mm Poly Orifice	24C806	EP 250 Poly Side Orifice
0.71 mm Poly Orifice	24C807	EP 250 Poly Side Orifice
0.89 mm Poly Orifice	24C808	EP 250 Poly Side Orifice
0.99 mm Poly Orifice	24C809	EP 250 Poly Side Orifice
1.07 mm Poly Orifice	24C810	EP 250 Poly Side Orifice
1.32 mm Poly Orifice	24C811	EP 250 Poly Side Orifice
1.40 mm Poly Orifice	24C812	EP 250 Poly Side Orifice
1.60 mm Poly Orifice	24C813	EP 250 Poly Side Orifice
1.85 mm Poly Orifice	24C815	EP 250 Poly Side Orifice
Orifice Kit	24E251	EP 375, 6 Blue, 6 Red
0.51 mm Poly Orifice	24C761	EP 375 Poly Side Orifice, Std

0.79 mm Poly Orifice	24C762	EP 375 Poly Side Orifice, Std
1.19 mm Poly Orifice	24C763	EP 375 Poly Side Orifice, Std
1.52 mm Poly Orifice	24C764	EP 375 Poly Side Orifice, Std
1.70 mm Poly Orifice	24C765	EP 375 Poly Side Orifice, Std
2.18 mm Poly Orifice	24C766	EP 375 Poly Side Orifice, Std
0.41 mm Poly Orifice	24C794	EP 375 Poly Side Orifice
0.61 mm Poly Orifice	24C795	EP 375 Poly Side Orifice
0.71 mm Poly Orifice	24C796	EP 375 Poly Side Orifice
0.89 mm Poly Orifice	24C797	EP 375 Poly Side Orifice
0.99 mm Poly Orifice	24C798	EP 375 Poly Side Orifice
1.07 mm Poly Orifice	24C799	EP 375 Poly Side Orifice
1.32 mm Poly Orifice	24C800	EP 375 Poly Side Orifice
1.40 mm Poly Orifice	24C801	EP 375 Poly Side Orifice
1.60 mm Poly Orifice	24C802	EP 375 Poly Side Orifice
1.85 mm Poly Orifice	24C804	EP 375 Poly Side Orifice

Iso A (Red) Applicator Orifice

S-Head and L-Head

The A (Red) applicator orifices for the S-Head and L-Head are the same as the B (Blue) applicator orifices. See page 11.

GX-16

Description	Part
257701	0.011 in. Orifice
257702	0.013 in. Orifice
257703	0.016 in. Orifice
257704	0.018 in. Orifice
257705	0.020 in. Orifice
257706	0.022 in. Orifice
257707	0.023 in. Orifice
257708	0.024 in. Orifice
257709	0.025 in. Orifice
257710	0.026 in. Orifice
257711	0.028 in. Orifice
257712	0.029 in. Orifice
257713	0.032 in. Orifice
257714	0.035 in. Orifice
257715	0.036 in. Orifice
257716	0.038 in. Orifice
257717	0.039 in. Orifice
257718	0.040 in. Orifice
257719	0.042 in. Orifice
257720	0.043 in. Orifice
257721	0.044 in. Orifice
257722	0.049 in. Orifice
257723	0.052 in. Orifice
257724	0.061 in. Orifice
24K682	0.085 in. Orifice

EP Gun

Description	Part	For Use With Applicator:
0.51 mm Iso Orifice	24D223	EP 250 Iso Side Orifice, Std
0.79 mm Iso Orifice	24D224	EP 250 Iso Side Orifice, Std
1.19 mm Iso Orifice	24D225	EP 250 Iso Side Orifice, Std
1.52 mm Iso Orifice	24D226	EP 250 Iso Side Orifice, Std
1.70mm Iso Orifice	24D227	EP 250 Iso Side Orifice, Std
2.18 mm Iso Orifice	24D228	EP 250 Iso Side Orifice, Std
0.41 mm Iso Orifice	24D229	EP 250 Iso Side Orifice
0.61 mm Iso Orifice	24D230	EP 250 Iso Side Orifice

0.71 mm Iso Orifice	24D231	EP 250 Iso Side Orifice
0.89 mm Iso Orifice	24D232	EP 250 Iso Side Orifice
0.99 mm Iso Orifice	24D233	EP 250 Iso Side Orifice
1.07 mm Iso Orifice	24D234	EP 250 Iso Side Orifice
1.32 mm Iso Orifice	24D235	EP 250 Iso Side Orifice
1.40 mm Iso Orifice	24D236	EP 250 Iso Side Orifice
1.60 mm Iso Orifice	24D237	EP 250 Iso Side Orifice
1.85 mm Iso Orifice	24D238	EP 250 Iso Side Orifice
0.51 mm Iso Orifice	24D239	EP 375 Iso Side Orifice, Std
0.79 mm Iso Orifice	24D240	EP 375 Iso Side Orifice, Std
1.19 mm Iso Orifice	24D241	EP 375 Iso Side Orifice, Std
1.52 mm Iso Orifice	24D242	EP 375 Iso Side Orifice, Std
1.70 mm Iso Orifice	24D243	EP 375 Iso Side Orifice, Std
2.18 mm Iso Orifice	24D244	EP 375 Iso Side Orifice, Std
0.41 mm Iso Orifice	24D245	EP 375 Iso Side Orifice
0.61 mm Iso Orifice	24D246	EP 375 Iso Side Orifice
0.71 mm Iso Orifice	24D247	EP 375 Iso Side Orifice
0.89 mm Iso Orifice	24D248	EP 375 Iso Side Orifice
0.99 mm Iso Orifice	24D249	EP 375 Iso Side Orifice
1.07 mm Iso Orifice	24D250	EP 375 Iso Side Orifice
1.32 mm Iso Orifice	24D251	EP 375 Iso Side Orifice
1.40 mm Iso Orifice	24D252	EP 375 Iso Side Orifice
1.60 mm Iso Orifice	24D253	EP 375 Iso Side Orifice
1.85 mm Iso Orifice	24D254	EP 375 Iso Side Orifice

AC Power Pack with S-Head/L-Head Hoses, Optional Boom

Part	Description
24D829	230V, Boom, L-Head Hoses
24D830	230V, Boom, S-Head Hoses
24D834	400V, Boom, L-Head Hoses
24D835	400V, Boom, S-Head Hoses
24D831	230V, L-Head Hoses, No Boom
24D832	230V, S-Head Hoses, No Boom
24D836	400V, L-Head Hoses, No Boom
24D837	400V, S-Head Hoses, No Boom
24F297	230V, L-Head Application, No Boom, No Hoses
24J912	230V, S-Head Application, No Boom, No Hoses
24F298	400V, L-Head Application, No Boom, No Hoses
24J913	230V, S-Head Application, No Boom, No Hoses
257798	Power Pack GX-16 Connection Kit
24E347	Hydraulic Power Pack Level Sensor Kit
24C872	Hydraulic Power Pack Pressure Gauge Kit
24E348	Hydraulic Power Pack Temperature Sensor
124217	Power Pack Accumulator Charging kit

Dispense Valve Interface Kit

Part	Description
24C757	MD2 Valve Solenoid, Machine Mount
24D160	MD2 Valve Solenoid, Remote Mount
24D161	Auto-Fusion Solenoid for Fusion Dispense Valve
24C067	Fusion Gun Pressure Adjust Kit

Flow Meters

Flow Meter Electronics (Necessary)

Part	Description
24J318	Flow Meter Electronics Kit

“A” and “B” Side Flow Meter (One for each side)

Part	Description
24J319	S3000 Flow Meter Kit (0.01 to 0.53 gpm, 50 to 2000 cc per min) (1 to 1000 cps)
24J320	G3000 Flow Meter Kit (0.02 to 1.0 gpm, 75 to 3800 cc per min) (20 to 3000 cps)
24J321	G3000HR Flow Meter Kit (0.01 to 0.5 gpm, 38 to 1900 cc per min) (20 to 3000 cps)
24J322	HG6000 Flow Meter Kit (0.013 to 6.0 gpm, 50 to 22,700 cc per min) (30 to 1,000,000 cps)
24J323	HG6000HR Flow Meter Kit (0.007 to 2.0 gpm, 25 to 7571 cc per min) (30 to 1,000,000,cps)

Flow Meter Calibration Kit (per applicator)

Part	Description
24J324	L-Head Flow Meter Calibration Kit
24J325	S-Head Flow Meter Calibration Kit
24J326	P2 Flow Meter Calibration Kit
24J357	GX-16 Flow Meter Calibration Kit
24F227	EP/Fusion Flow Meter Calibration Kit
255247	MD2 1:1 Flow Meter Calibration Kit
255245	MD2 10:1 Flow Meter Calibration Kit

Pump Feed Kits

Part	Description
246081	2:1 (Air/Fluid) Carbon Steel Complete Supply Pump Kit
246369	H515 (Air/Fluid) Carbon Steel Complete Supply Pump Kit
246375	H716 (Air/Fluid) Carbon Steel Complete Supply Pump Kit
24D328	H1050 (Air/Fluid) Carbon Steel Complete Supply Pump Kit
257769	High-Flo® (Air/Fluid) Carbon Steel Complete Supply Pump Kit
24D091	2:1 (Air/Fluid) Stainless Steel Complete Supply Pump Kit
24D092	H515 (Air/Fluid) Stainless Steel Complete Supply Pump Kit
24D093	H716 (Air/Fluid) Stainless Steel Complete Supply Pump Kit
24D094	H1050 (Air/Fluid) Stainless Steel Complete Supply Pump Kit
24D095	5:1 Monarch 55G Stainless Steel Complete Supply Pump Kit
24D096	5:1 Monarch 5G Stainless Steel Complete Supply Pump Kit
257777	High-Flo Stainless Steel Complete Supply Pump Kit
246366	Husky™ 515 Pump, Drum with Riser Tube
246367	Husky 716 Pump, Drum with Riser Tube
24D329	Husky 1050 Pump, Drum with Riser Tube
233052	Husky 515 Diaphragm Pump, Drum with Riser Tube
233057	Husky 716 Diaphragm Pump, Drum with Riser Tube
24D097	Husky 1050 SS Pump, Drum with Riser Tube
295616	2:1 (Air/Fluid) Stainless Steel Supply Pumps with Riser Tubes
24D098	5:1 Monarch, 5G, Stainless Steel Supply Pumps with Riser Tubes
24D099	5:1 Monarch, 55G, Stainless Steel Supply Pumps with Riser Tubes
246481	Husky 515 Pump with Carbon Steel Fluid Plumbing
246482	Husky 716 Pump with Carbon Steel Fluid Plumbing
24D332	Husky 1050 Pump with Carbon Steel Fluid Plumbing
246898	2:1 Supply Pump with Carbon Steel Fluid Plumbing
24D100	Husky 515 Pump with Stainless Steel Fluid Plumbing
24D101	Husky 716 Pump with Stainless Steel Fluid Plumbing

24D102	Husky 1050 Pump with Stainless Steel Fluid Plumbing
24D103	2:1 Supply Pump with Stainless Steel Fluid Plumbing
24D104	5:1 Monarch Pump with Stainless Steel Fluid Plumbing
24D105	5:1 Monarch Pump with Stainless Steel Fluid Plumbing
24E396	One 2:1 T-2 Pump, Carbon Steel
24E397	One 2:1 T-2 Pump, Stainless Steel
24E398	One Monarch 5:1 Pump, 5G
24E399	One Monarch 5:1 Pump, 55G
246419	Carbon Steel Riser Tube Assembly
246477	Carbon Steel Return Tube
246483	Air Supply for Feed Pump and Gun
247616	Desiccant Dryer
15C381	Desiccant Dryer Cartridge
233048	Drum Pump Accessory Kit
24D106	Stainless Steel Return Tube Accessory Kit
24D107	Stainless Steel Circulation Accessory
24E379	Carbon Steel Circulation Accessory Kit
244053	26 sq. in., 60 mesh, Stainless Steel Fluid Filter
116178	26 sq. in., 30 mesh, Stainless Steel Fluid Filter Element
116179	26 sq. in., 60 mesh, Stainless Steel Fluid Filter Element
116180	26 sq. in., 100 mesh, Stainless Steel Fluid Filter Element
116181	26 sq. in., 200 mesh, Stainless Steel Fluid Filter Element
213058	36 sq. in., 60 mesh, Carbon Steel Fluid Filter
108106	36 sq. in., 30 mesh, Carbon Steel Fluid Filter Element
108107	36 sq. in., 60 mesh, Carbon Steel Fluid Filter Element
108108	36 sq. in., 100 mesh, Carbon Steel Fluid Filter Element
108109	36 sq. in., 150 mesh, Carbon Steel Fluid Filter Element
108110	36 sq. in., 200 mesh, Carbon Steel Fluid Filter Element

B (Blue) and A (Red) Feed Tanks

Part	Description
24D562	38L Tank, No Agitation, Chiller, Desiccant, 2 Level Sensors
24D564	38L Tank, Agitation, Chiller, Desiccant, 2 Level Sensors
24D565	75L Tank, No Agitation, Chiller, Desiccant, 2 Level Sensors
24C317	75L Tank, Agitation, Chiller, Desiccant, 2 Level Sensors
24D568	38L Tank, No Agitation, No Level Sensors
24D569	38L Tank, No Agitation, 2 Level Sensors
24D570	38L Tank, Agitation, 2 Level Sensors
24D571	38L Tank, Agitation, Slinger Plate, 2 Level Sensors
24D572	38L Tank, Agitation, Slinger Plate, Heat, Insulation, 2 Level Sensors
24D573	38L Tank, Agitation, Heat, Insulation, 2 Level Sensors
24D574	75L Tank, No Agitation, No Level Sensors
24D575	75L Tank, No Agitation, 2 Level Sensors
24D576	75L Tank, Agitation, 2 Level Sensors
24D577	75L Tank, Agitation, Slinger Plate, 2 Level Sensors
24D578	75L Tank, Agitation, Slinger Plate, Heat, Insulation, 2 Level Sensors
24D579	75L Tank, Agitation, Heat, Insulation, 2 Level Sensors
257757	Insulator Blanket for 38L Tank
257758	Insulator Blanket for 75L Tank
257770	Refill Kit For Customer Supplied Feed System
257778	Nitrogen Kit For 1 Tank
257779	Nitrogen Kit For 2 Tanks
257916	Vacuum Pump Kit, 6.9 cfm, 1st, 230V, 1 phase
24D271	3rd Level Sensor Prox Switch Option
LC0097	Desiccant Dryer, 3/8 in. Npt With Adapter And Cartridge
LC0098	Desiccant Dryer Refill Cartridge
24G952	20gal (75L) Carbon Steel Tank, 2 Level Sensors
24G953	20gal (75L) Carbon Steel Tank, 2 Level Sensors, Variable Speed Pneumatic Agitator
24G955	20gal (75L) Carbon Steel Tank, 2 Level Sensors, Variable Speed Electric Agitator
24G956	20gal (75L) Carbon Steel Tank, 2 Level Sensors, Chiller Control Valve, Heat Exchanger
24G957	20gal (75L) Carbon Steel Tank, 2 Level Sensors, Variable Speed Pneumatic Agitator, Chiller Control Valve, Heat Exchanger
24G959	20gal (75L) Carbon Steel Tank, 2 Level Sensors, Variable Speed Electric Agitator, Chiller Control Valve, Heat Exchanger

24J209	20gal (75L) Stainless Steel Tank, 3 Level Sensors, Insulated
24J707	20gal (75L) Carbon Steel Tank, 3 Level Sensors, Insulated
24J243	2gal (7.6L) Stainless Steel Tank

Additional Accessories

Miscellaneous

Part	Description
24C871	Hydraulic Power Pack Hydraulic Tank Fluid Level Sensor
24C873	Hydraulic Power Pack Manifold Oil Temperature Sensor
24P090	Mobile Pallet Base with Casters
24F516	IsoGuard Select fluid, 6 quarts
121728	Extension Cable for Advanced Display Module, 4 meter,
255244	Foot Switch with Guard and 4 meter Cable
24F227	EP and Fusion Gun Ratio Check
24F235	25 ft hose extensions for L-Head applicator; material, hydraulic, and signal cables
24F236	50 ft hose extensions for L-Head applicator; material, hydraulic, and signal cables
24F237	25 ft hose extensions for S-Head applicator; material, hydraulic, and signal cable
24F238	50 ft hose extensions for S-Head applicator; material, hydraulic, and signal cable
24K206	Nip Sensor Kit
24H019	Air Inlet Filter for Hydraulic Power Pack
255468	Light Tower Kit

Communications Gateway Module (CGM)

The HFR Communication Gateway Module allows the user to control an HFR through an external control device such as a PLC. The CGM operates in conjunction with the existing Advanced Display Module (ADM) such that both devices can be used to control the machine. See HFR Communication Gateway Module manual for more information

Part	Description
24J415	CGM Mounting Kit (Required)
CGMDN0	GCA Gateway Module, DeviceNet Fieldbus
CGMEP0	GCA Gateway Module, EtherNet/IP Fieldbus
CGMPB0	GCA Gateway Module, PROFIBUS Fieldbus
CGMPN0	GCA Gateway Module, PROFINET Fieldbus





Discrete Gateway Module (DGM)

The HFR Discrete Gateway Module allows the user to control an HFR through multiple external control devices such as contact blocks or relays. The DGM operates in conjunction with the existing Advanced Display Module (ADM) such that both devices can be used to control the machine. See HFR Communication Gateway Module manual for more information

Part	Description
24F843	Single DGM Cube with Board
24F844	Two DGM Cubes with Board
24G830	Single DGM Cube

Warnings

The following warnings are for the setup, use, grounding, maintenance, and repair of this equipment. The exclamation point symbol alerts you to a general warning and the hazard symbol refers to procedure-specific risk. Refer back to these warnings. Additional, product-specific warnings may be found throughout the body of this manual where applicable.

 WARNING	
	<p>ELECTRIC SHOCK HAZARD</p> <p>This equipment must be grounded. Improper grounding, setup, or usage of the system can cause electric shock.</p> <ul style="list-style-type: none"> • Turn off and disconnect power at main switch before disconnecting any cables and before servicing equipment. • Connect only to grounded power source. • All electrical wiring must be done by a qualified electrician and comply with all local codes and regulations.
	<p>TOXIC FLUID OR FUMES HAZARD</p> <p>Toxic fluids or fumes can cause serious injury or death if splashed in the eyes or on skin, inhaled, or swallowed.</p> <ul style="list-style-type: none"> • Read MSDSs to know the specific hazards of the fluids you are using. • Store hazardous fluid in approved containers, and dispose of it according to applicable guidelines. • Always wear chemically impermeable gloves when spraying, dispensing, or cleaning equipment.
	<p>PERSONAL PROTECTIVE EQUIPMENT</p> <p>You must wear appropriate protective equipment when operating, servicing, or when in the operating area of the equipment to help protect you from serious injury, including eye injury, hearing loss, inhalation of toxic fumes, and burns. This equipment includes but is not limited to:</p> <ul style="list-style-type: none"> • Protective eyewear, and hearing protection. • Respirators, protective clothing, and gloves as recommended by the fluid and solvent manufacturer.
	<p>SKIN INJECTION HAZARD</p> <p>High-pressure fluid from dispensing device, hose leaks, or ruptured components will pierce skin. This may look like just a cut, but it is a serious injury that can result in amputation. Get immediate surgical treatment.</p> <ul style="list-style-type: none"> • Do not point dispensing device at anyone or at any part of the body. • Do not put your hand over the fluid outlet. • Do not stop or deflect leaks with your hand, body, glove, or rag. • Follow the Pressure Relief Procedure when you stop dispensing and before cleaning, checking, or servicing equipment. • Tighten all fluid connections before operating the equipment. • Check hoses and couplings daily. Replace worn or damaged parts immediately.

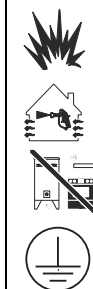
WARNING
**FIRE AND EXPLOSION HAZARD**

Flammable fumes, such as solvent and paint fumes, in **work area** can ignite or explode. To help prevent fire and explosion:

- Use equipment only in well ventilated area.
- Eliminate all ignition sources; such as pilot lights, cigarettes, portable electric lamps, and plastic drop cloths (potential static arc).
- Keep work area free of debris, including solvent, rags and gasoline.
- Do not plug or unplug power cords, or turn power or light switches on or off when flammable fumes are present.
- Ground all equipment in the work area. See **Grounding** instructions.
- Use only grounded hoses.
- Hold gun firmly to side of grounded pail when triggering into pail.
- If there is static sparking or you feel a shock, **stop operation immediately**. Do not use equipment until you identify and correct the problem.
- Keep a working fire extinguisher in the work area.

**PRESSURIZED EQUIPMENT HAZARD**





Fluid from the gun/dispense valve, leaks, or ruptured components can splash in the eyes or on skin and cause serious injury.

- Follow the **Pressure Relief Procedure** when you stop spraying and before cleaning, checking, or servicing equipment.
- Tighten all fluid connections before operating the equipment.
- Check hoses, tubes, and couplings daily. Replace worn or damaged parts immediately.

**EQUIPMENT MISUSE HAZARD**





Misuse can cause death or serious injury.

- Do not operate the unit when fatigued or under the influence of drugs or alcohol.
- Do not exceed the maximum working pressure or temperature rating of the lowest rated system component. See **Technical Data** in all equipment manuals.
- Use fluids and solvents that are compatible with equipment wetted parts. See **Technical Data** in all equipment manuals. Read fluid and solvent manufacturer's warnings. For complete information about your material, request MSDS from distributor or retailer.
- Do not leave the work area while equipment is energized or under pressure. Turn off all equipment and follow the **Pressure Relief Procedure** when equipment is not in use.
- Check equipment daily. Repair or replace worn or damaged parts immediately with genuine manufacturer's replacement parts only.
- Do not alter or modify equipment.
- Use equipment only for its intended purpose. Call your distributor for information.
- Route hoses and cables away from traffic areas, sharp edges, moving parts, and hot surfaces.
- Do not kink or over bend hoses or use hoses to pull equipment.
- Keep children and animals away from work area.
- Comply with all applicable safety regulations.



 WARNING	
 	<p>MOVING PARTS HAZARD Moving parts can pinch, cut or amputate fingers and other body parts.</p> <ul style="list-style-type: none"> • Keep clear of moving parts. • Do not operate equipment with protective guards or covers removed. • Pressurized equipment can start without warning. Before checking, moving, or servicing equipment, follow the Pressure Relief Procedure and disconnect all power sources.
	<p>BURN HAZARD Equipment surfaces and fluid that's heated can become very hot during operation. To avoid severe burns:</p> <ul style="list-style-type: none"> • Do not touch hot fluid or equipment.

Important Two-Component Material Information



Isocyanate Conditions

						
<p>Spraying or dispensing materials containing isocyanates creates potentially harmful mists, vapors, and atomized particulates.</p> <p>Read material manufacturer's warnings and material MSDS to know specific hazards and precautions related to isocyanates.</p> <p>Prevent inhalation of isocyanate mists, vapors, and atomized particulates by providing sufficient ventilation in the work area. If sufficient ventilation is not available, a supplied-air respirator is required for everyone in the work area.</p> <p>To prevent contact with isocyanates, appropriate personal protective equipment, including chemically impermeable gloves, boots, aprons, and goggles, is also required for everyone in the work area.</p>						

Keep Components A (Red) and B (Blue) Separate

						
<p>Cross-contamination can result in cured material in fluid lines which could cause serious injury or damage equipment. To prevent cross-contamination of the equipment's wetted parts, never interchange component A (Red) and component B (Blue) parts.</p>						

Material Self-ignition

						
<p>Some materials may become self-igniting if applied too thickly. Read material manufacturer's warnings and material MSDS.</p>						

Moisture Sensitivity of Isocyanates

Isocyanates (ISO) are catalysts used in two component foam and polyurea coatings. ISO will react with moisture (such as humidity) to form small, hard, abrasive crystals, which become suspended in the fluid. Eventually a film will form on the surface and the ISO will begin to gel, increasing in viscosity. If used, this partially cured ISO will reduce performance and the life of all wetted parts.

NOTE: The amount of film formation and rate of crystallization varies depending on the blend of ISO, the humidity, and the temperature.

To prevent exposing ISO to moisture:

- Always use a sealed container with a desiccant dryer in the vent, or a nitrogen atmosphere. **Never** store ISO in an open container.
- Keep the ISO lube pump reservoir (if installed) filled with IsoGuard Select, part 24F516. The lubricant creates a barrier between the ISO and the atmosphere.
- Use moisture-proof hoses specifically designed for ISO, such as those supplied with your system.
- Never use reclaimed solvents, which may contain moisture. Always keep solvent containers closed when not in use.

A (Red) and B (Blue) Components

IMPORTANT!

Material suppliers can vary in how they refer to plural component materials.

Be aware that when standing in front of the manifold on proportioner:

- Component A (Red) is on the left side.
- Component B (Blue) is on the right side.

- Never use solvent on one side if it has been contaminated from the other side.
- Always lubricate threaded parts with ISO pump oil or grease when reassembling.

Foam Resins with 245 fa Blowing Agents

Some foam blowing agents will froth at temperatures above 90°F (33°C) when not under pressure, especially if agitated. To reduce frothing, minimize preheating in a circulation system.

Changing Materials

- When changing materials, flush the equipment multiple times to ensure it is thoroughly clean.
- Always clean the fluid inlet strainers after flushing.
- Check with your material manufacturer for chemical compatibility.
- Most materials use ISO on the A (Red) side, but some use ISO on the B (Blue) side. See the following section.

For all machines:

- The A (Red) side is intended for ISO, hardeners, and catalysts.
- If one of the materials being used is moisture-sensitive, that material should always be in the A (Red) side.
- The B (Blue) side is intended for polyols, resins, and bases.

NOTE: For machines with material volume ratios other than 1:1, the higher volume side is typically the B (Blue) side.

Typical Installation

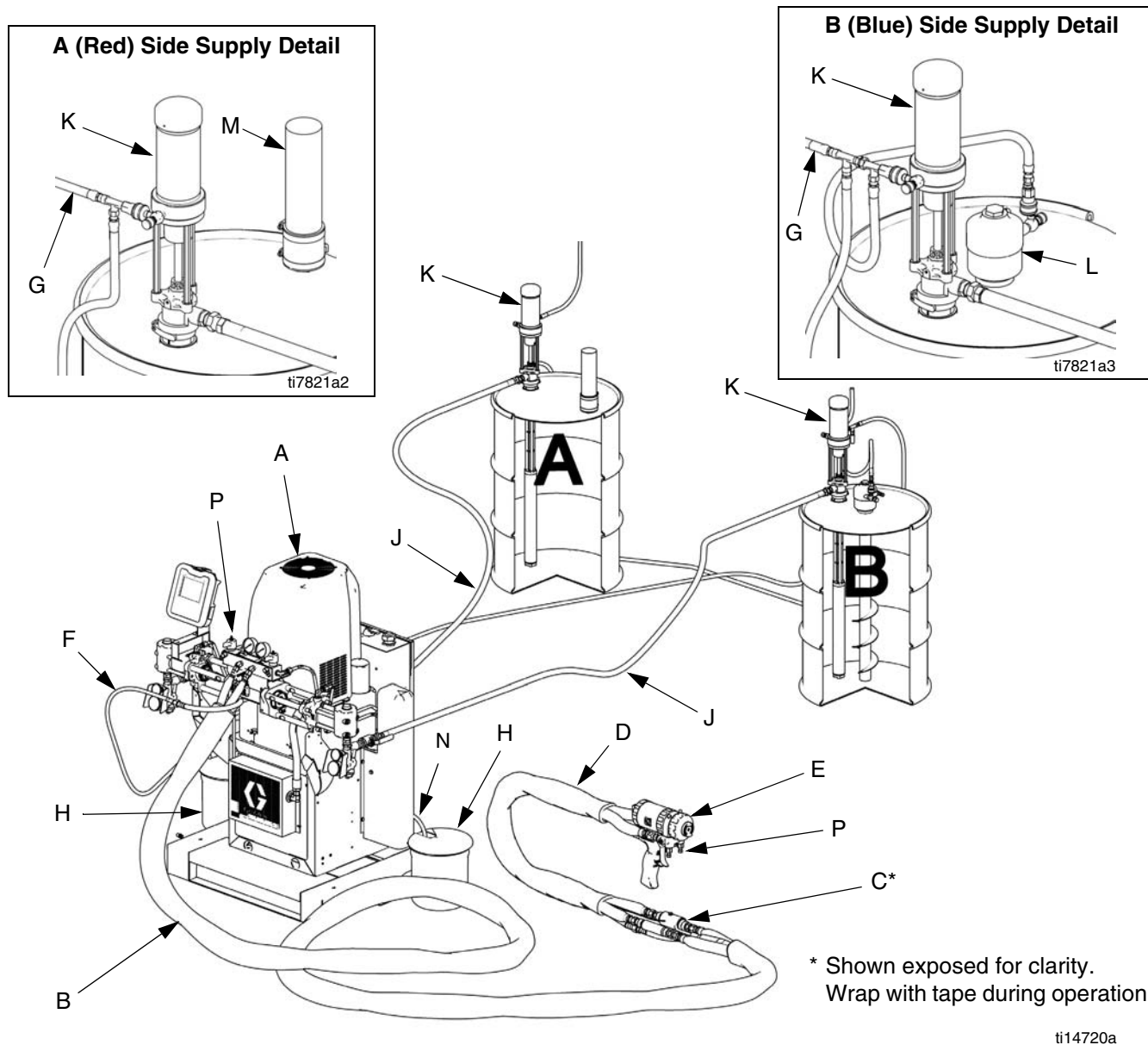

ti14720a

FIG. 1

Key:

- | | |
|---|-------------------|
| A HFR Unit (see FIG. 2, page 25) | K Feed Pumps |
| B Hose | L Agitator |
| C Fluid Temperature Sensor (FTS); 2x, 1 for each hose | M Desiccant Dryer |
| D Whip Hose | N Bleed Lines |
| E Dispense Gun | P Fluid Manifold |
| F Gun Air Supply Hose | |
| G Feed Pump Air Supply Lines | |
| H Waste Container | |
| J Fluid Supply Lines | |

Component Identification

Key for FIG. 2.

- AA Advanced Display Module (see page 30)
- BA Component A (Red) Pressure Relief Outlet
- BB Component B (Blue) Pressure Relief Outlet
- CO Base and Casters (Optional)
- FA Component A (Red) Fluid Manifold Inlet (on left side of manifold block)
- FB Component B (Blue) Fluid Manifold Inlet
- FM HFR Fluid Manifold
- FP Feed Inlet Pressure Gauge
- FS Feed Inlet Strainer (standard filter size is 20 mesh)
- FT Feed Inlet Temperature Gauge (heated models only)
- FV Feed Inlet Valve (A (Red) side shown)
- GA Component A (Red) Outlet Pressure Gauge
- GB Component B (Blue) Outlet Pressure Gauge
- HA Component A (Red) Hose Connection (from feed to gun or mix head)
- HB Component B (Blue) Hose Connection (from feed to gun or mix head)
- HP Hydraulic Power Pack Assembly
- HT Hydraulic Tank
- LR IsoGuard Select Fluid Reservoir
- LS Pumpline Linear Sensor
- MA Motor Control Module, see page 28
- MP Main Power Switch
- PA Component A (Red) Pump
- PB Component B (Blue) Pump
- PD Power Distribution Box
- PH Primary Heater
- PI Primary Heater Fluid Inlet
- PO Primary Heater Fluid Outlet
- PR Primary Heater RTD
- PS Primary Heater Overtemperature Switch
- SA Component A (Red) PRESSURE RELIEF/DISPENSE Valve
- SB Component B (Blue) PRESSURE RELIEF/DISPENSE Valve
- TA Component A (Red) Pressure Transducer
- TB Component B (Blue) Pressure Transducer
- TC High Power Temperature Control Module (not shown, see page 34)

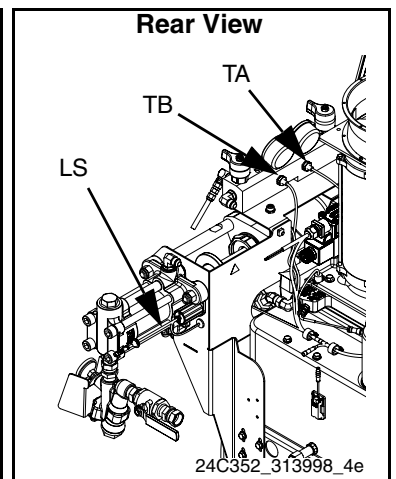
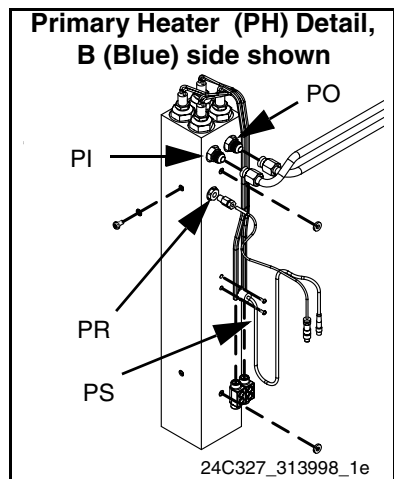
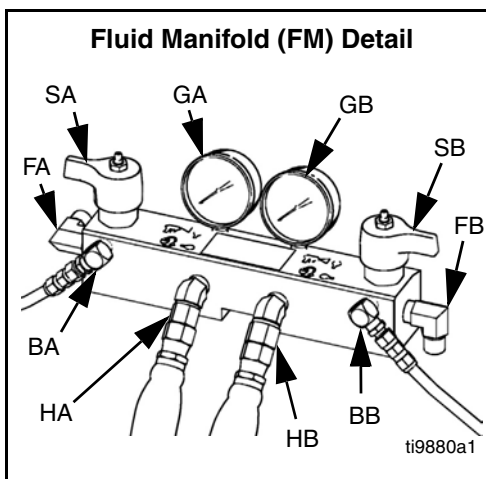
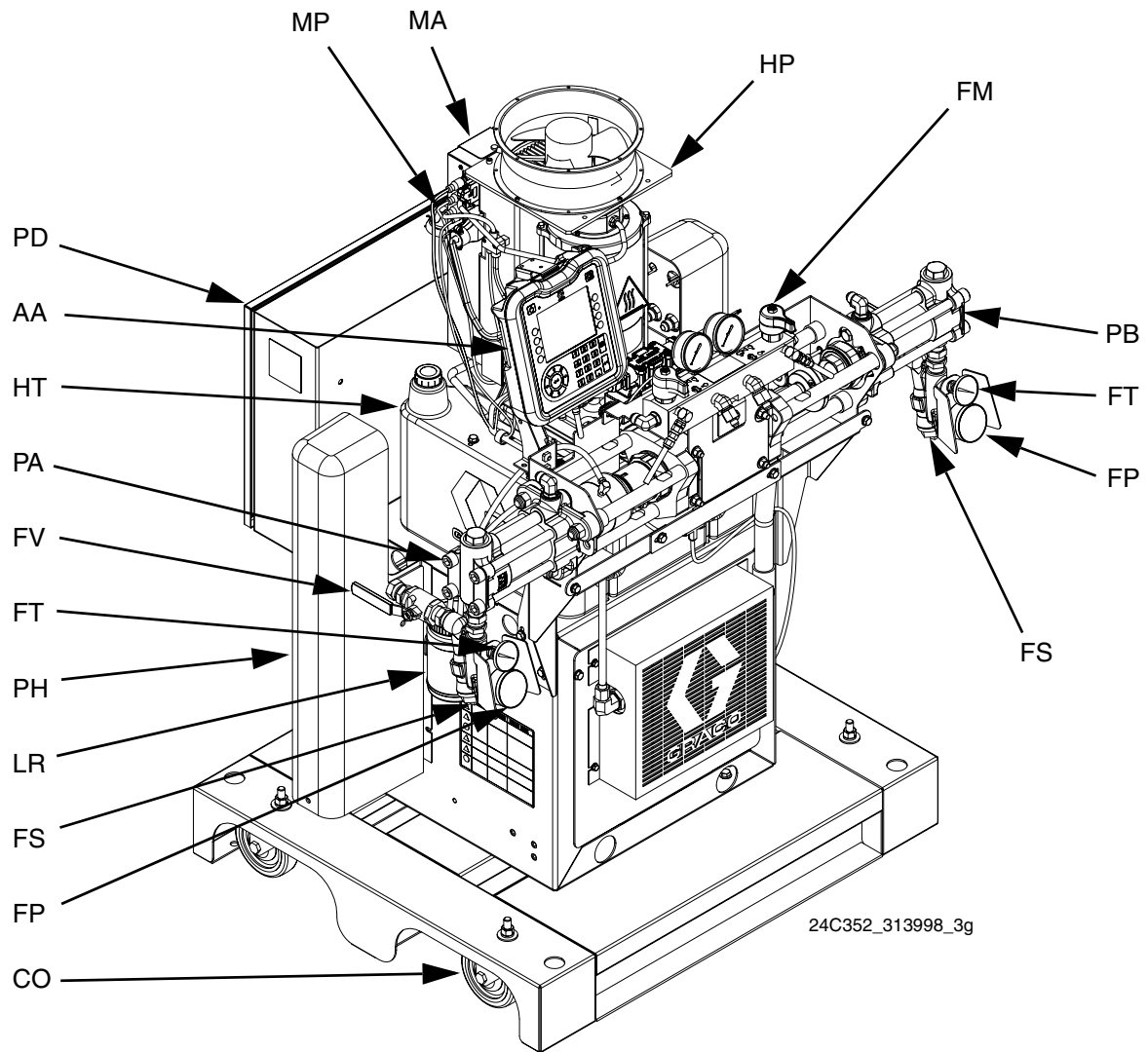



FIG. 2: Component Identification, Heated Model shown with shrouds removed

Main Power Switch

Located on top of the power distribution box, see page 25. The main power switch turns power

ON  and OFF . The main power switch does not turn pumps or heat zones on.

Circuit Breakers

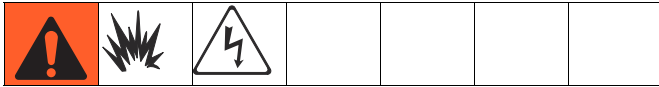

Most circuit breakers are located inside the power distribution box. The main block of circuit breakers in the power distribution box is shown below, with detailed information in the following table. For more information about items in the power distribution box, see power distribution box manual for more information.

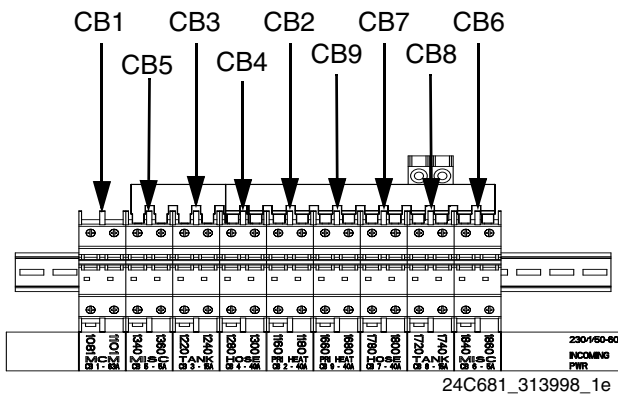

Ref.	Size		Component
	230V/ 1 phase, 400V/ 3 phase	230V/ 3 phase	
CB1	63A	30A	Motor Control Module
CB2	40A	40A	Primary Heater A
CB3	15A	15A	Tank Heat A
CB4	40A	40A	Hose Heat A
CB5	5A	5A	Miscellaneous
CB6	5A	5A	Miscellaneous
CB7	40A	40A	Hose Heat B
CB8	15A	15A	Tank Heat B
CB9	40A	40A	Primary Heater B

Additional circuit breakers for protection of the secondary side of the heated hose transformer are located inside the frame. See the parts list for the installed primary/hose heat option. See Ref. 5 of the product configurator code for your machine to determine which primary/hose heat option is installed. See **Product Configurator** on page 5.

B (Blue)
Left Side from Rear View

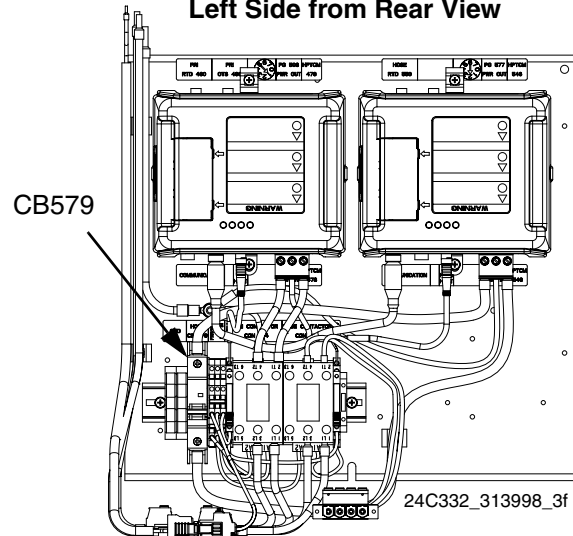

A (Red)
Right Side from Rear View

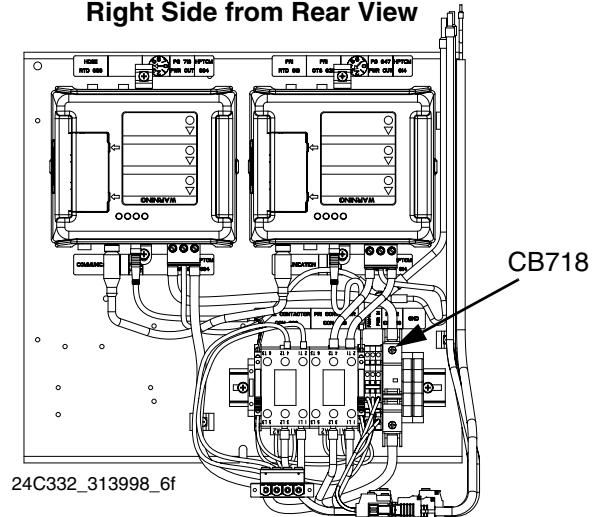

Hydraulic Power Pack

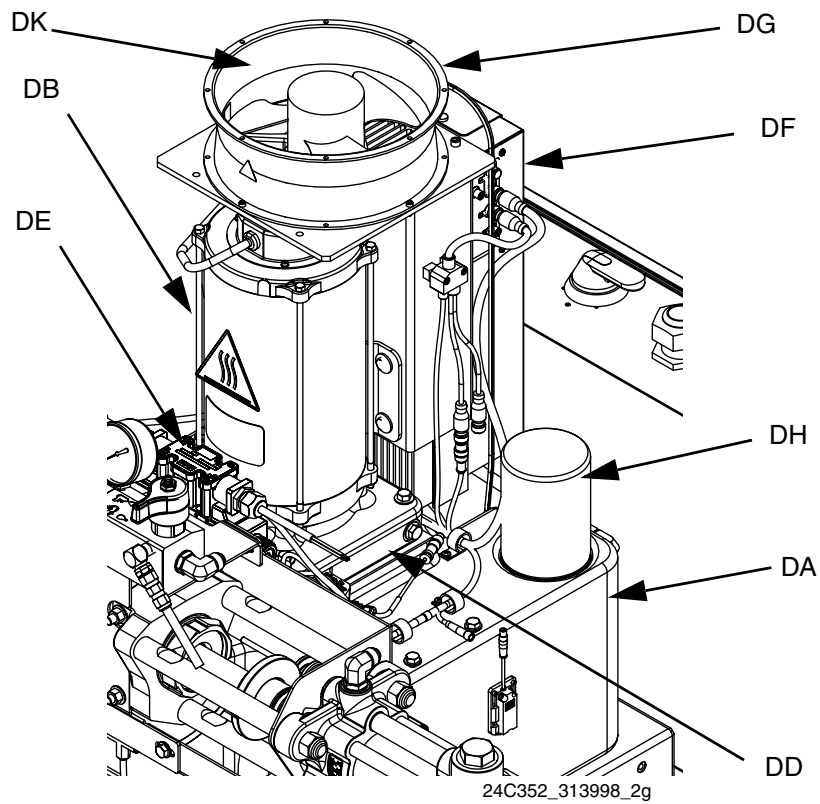

FIG. 3

Key:

DA 8 Gallon Hydraulic Oil Reservoir (see **Technical Data** on page 108 for specifications)
 DB Electric Motor
 DC Dipstick (not shown, located at rear left of hydraulic tank)
 DD Hydraulic Housing
 DE Directional Valve

DF Motor Control Module (see page 28)
 DG Fan
 DH Oil Filter
 DJ Shroud (not shown, removed for clarity)
 DK Air Inlet Filter

Motor Control Module (MCM)

NOTICE

If the Motor Control Module is replaced, the selector switch must be set prior to initial startup of the Motor Control Module or damage may occur. See HFR Repair manual for details, see **Related Manuals** on page 3.

For MCM location, see reference MA in FIG. 2 on page 25. When installed, the end of the MCM with the power input connection (12) faces down and the end with the access cover (A) faces up.

The Motor Control Module uses an 8-position selector switch to set the system maximum working pressure.

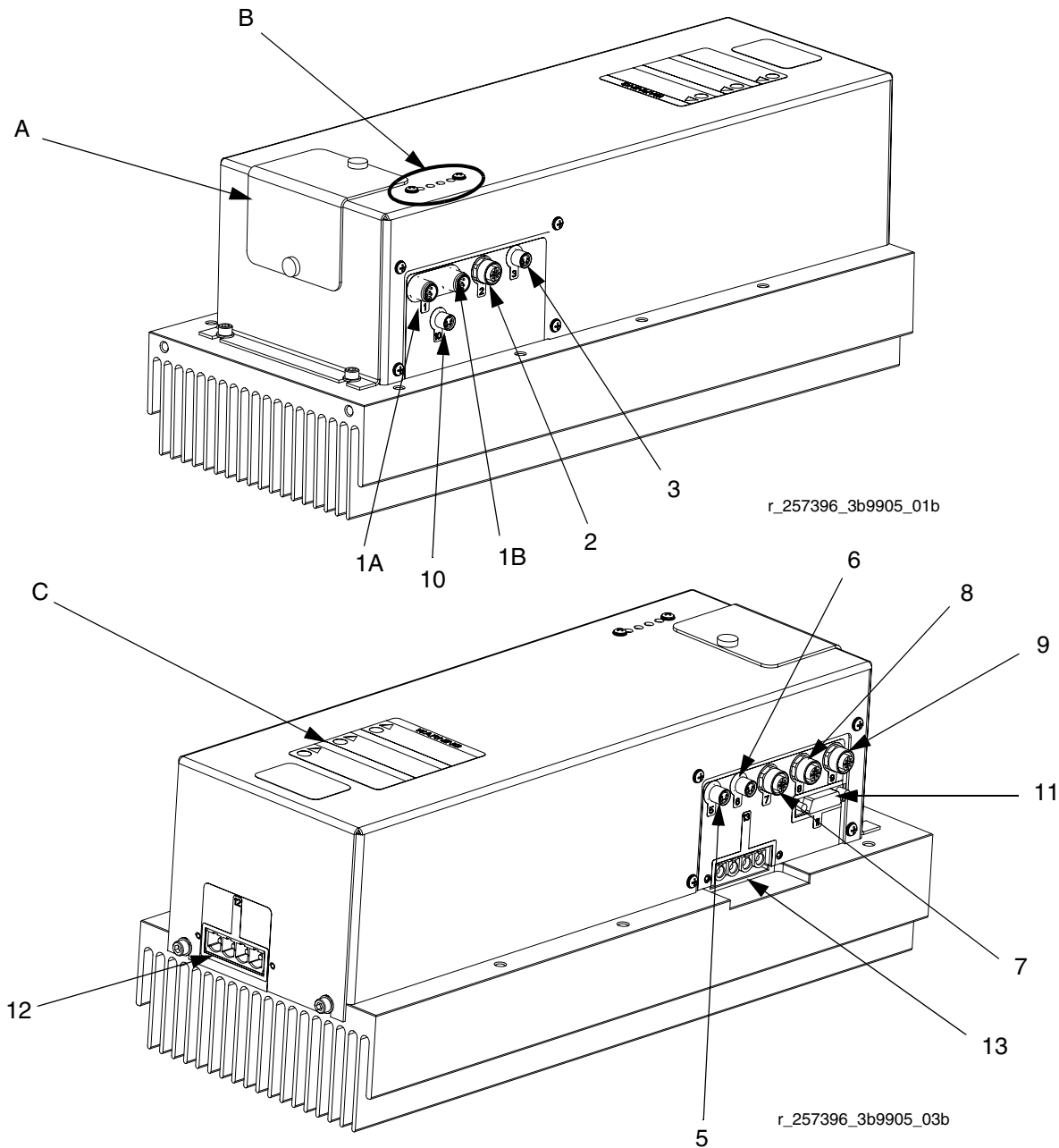
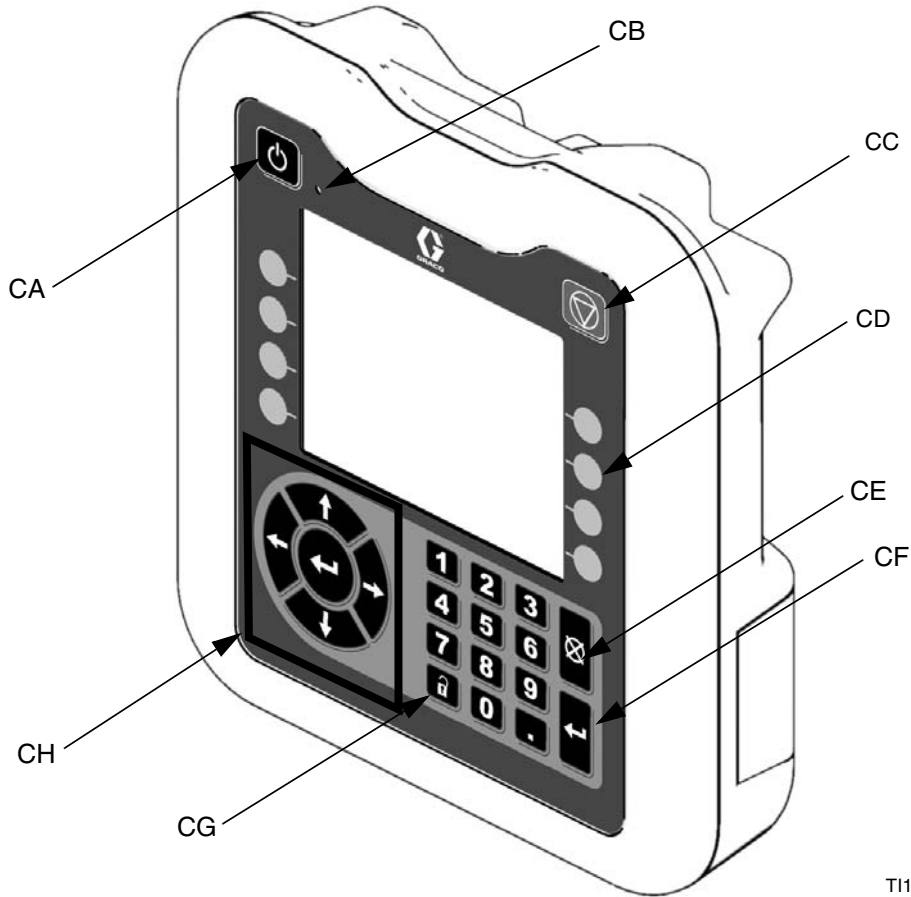

FIG. 4: MCM Component Identification

Ref	Description
A	Access Cover
B	LEDs
C	Warning Label
1A, 1B	CAN Connections
2	Three-way Splitter to: Oil Low Level Sensor, Dispense Valve Solenoid, and Footswitch
3	Oil Temperature Sensor
5	Electric Motor Temperature Sensor
6	LVDT
7	Three-way Splitter to: Hydraulic Directional Valve, Oil Overtemperature Switch
8	Pressure Transducer B (Blue) side
9	Pressure Transducer A (Red) side
10	Not used
11	Motor Position Sensor
12	MCM Power Input Connection
13	Motor Power Connection

Advanced Display Module (ADM)

User Interface



T112362a1

FIG. 5: ADM Component Identification - Front

Buttons

Ref.	Button	Function
CA	System enable/disable	Enables/disables system. When system is disabled, temperature control and dispense operation are disabled.
CB	System Status Indicator Light	Displays system status. See System Status Indicator (CB) Conditions on page 31 for details.
CC	Stop	Stops all system processes.

Ref.	Button	Function
CD	Soft Keys	Defined by application using ADM.
CE	Cancel	Cancel a selection or number entry while in the process of entering a number or making a selection.
CF	Enter	Acknowledge changing a value or making a selection.
CG	Lock/Set up	Toggle between run and setup screens. If setup screens are password protected, button toggles between run and password entry screen.
CH	Navigation	Navigate within a screen or to a new screen.

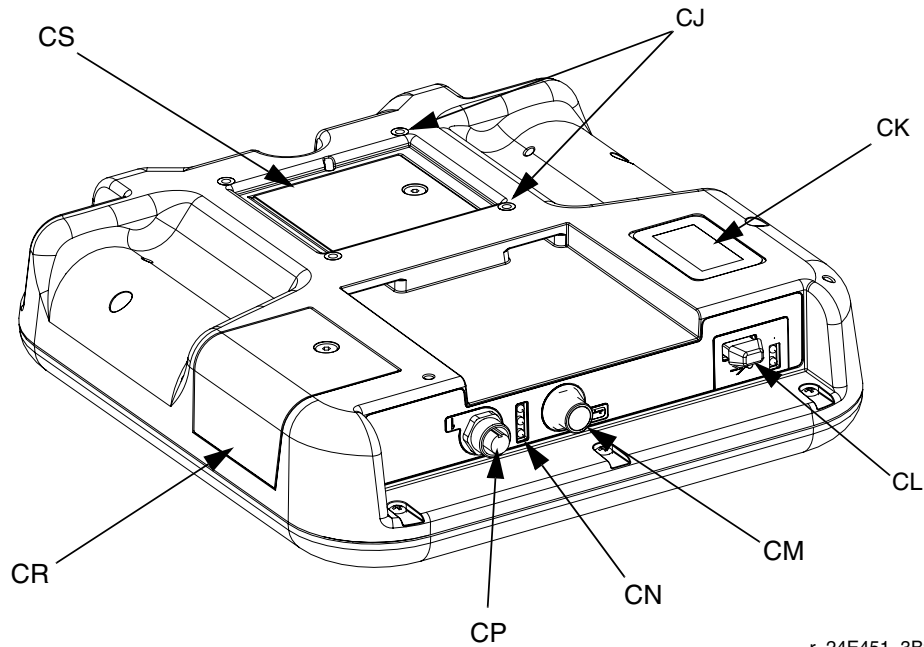

r_24E451_3B9900_1a

FIG. 6: ADM Component Identification - Rear

Key:

CJ Flat Panel Mount
 CK Model Number
 CL USB Module Interface
 CM CAN Cable Connections

CN Module Status LEDs
 CP Accessory Cable Connections
 CR Token Access Cover
 CS Battery Access Cover

System Status Indicator (CB) Conditions

Green Solid - Run Mode, System On
Green Flashing - Setup Mode, System On
Yellow Solid - Run Mode, System Off
Yellow Flashing - Setup Mode, System Off

Main Display Components

The following figure calls out the navigational, status, and general informational components of each screen. For details regarding the user interface display see **Advanced Display Module (ADM) Operation**, page 46.

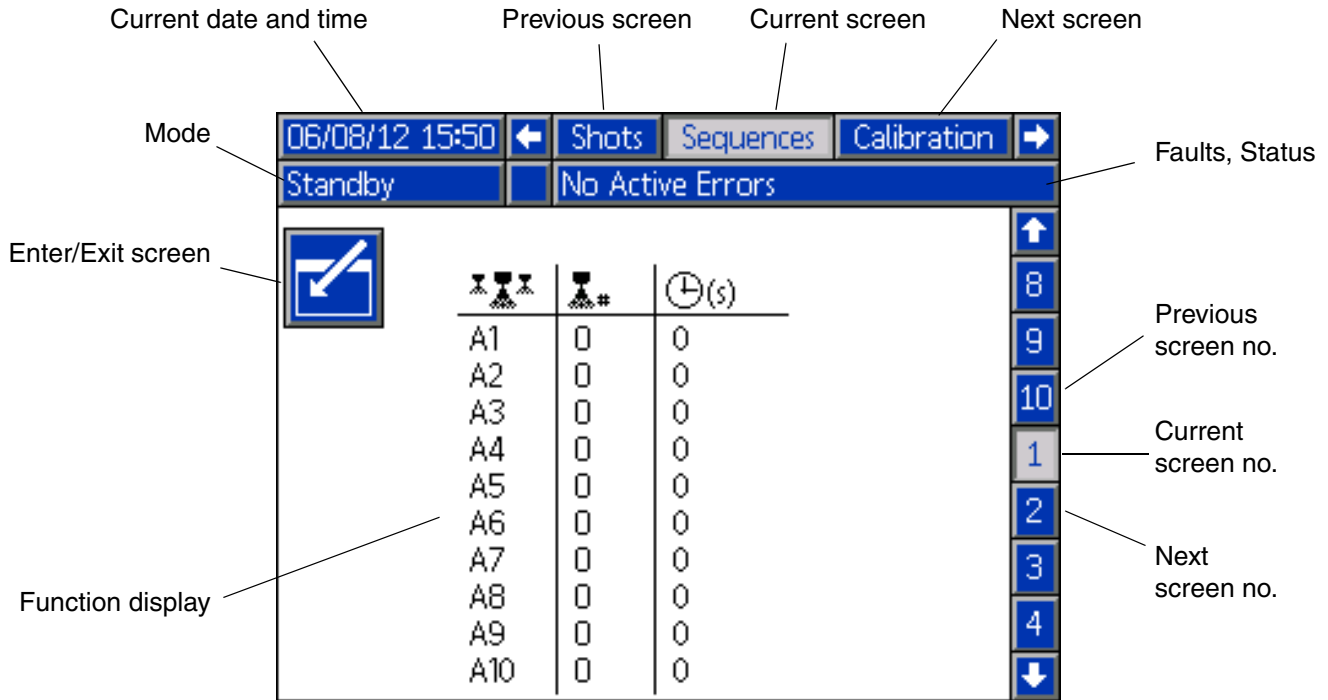

FIG. 7: Main Display Components

Fluid Control Module (FCM)

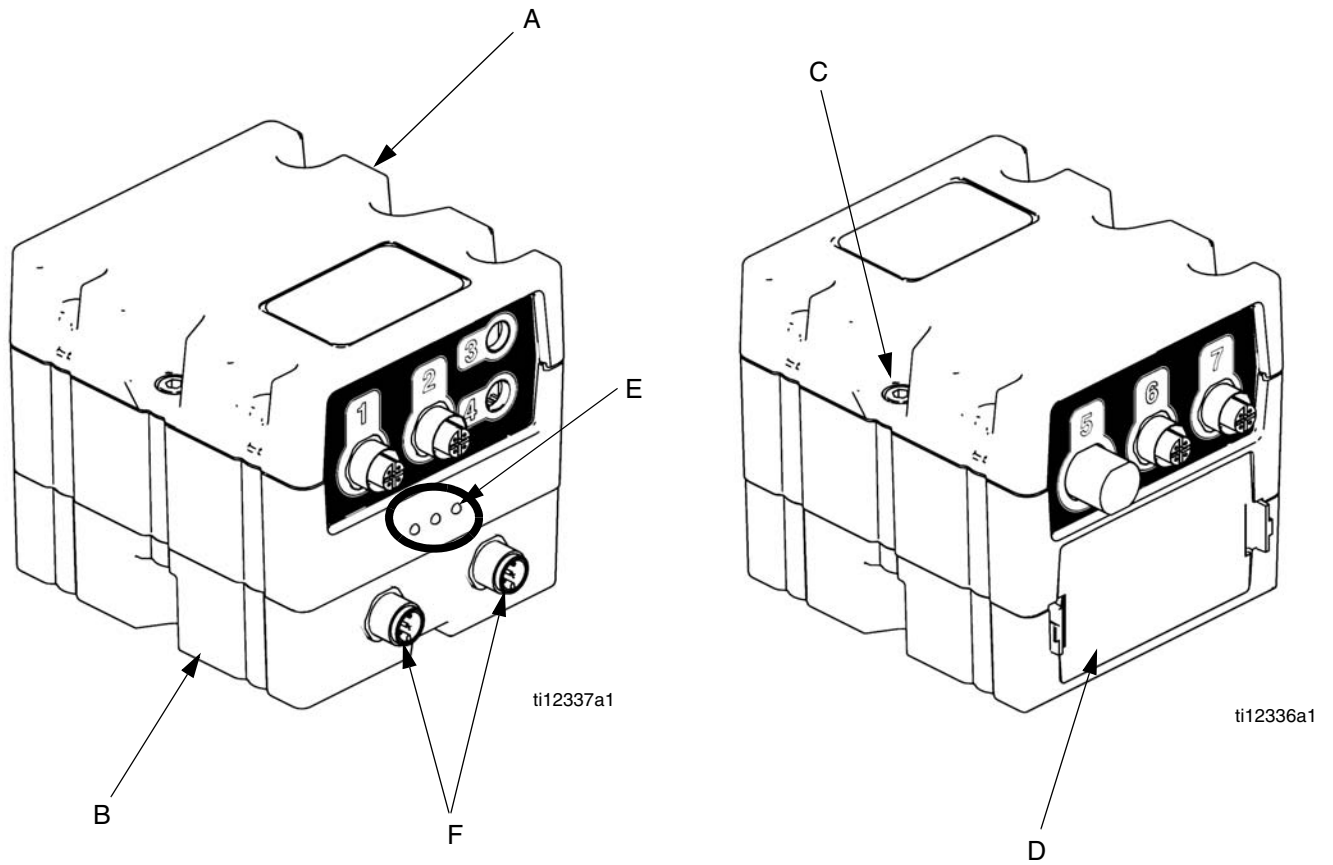

FIG. 8:

Key:

- A Fluid Control Module
- B Base
- C Module Connection Screws
- D Access Cover
- E Module Status LEDs
- F CAN Connectors

Temperature Control Module (Heated HFR Only)

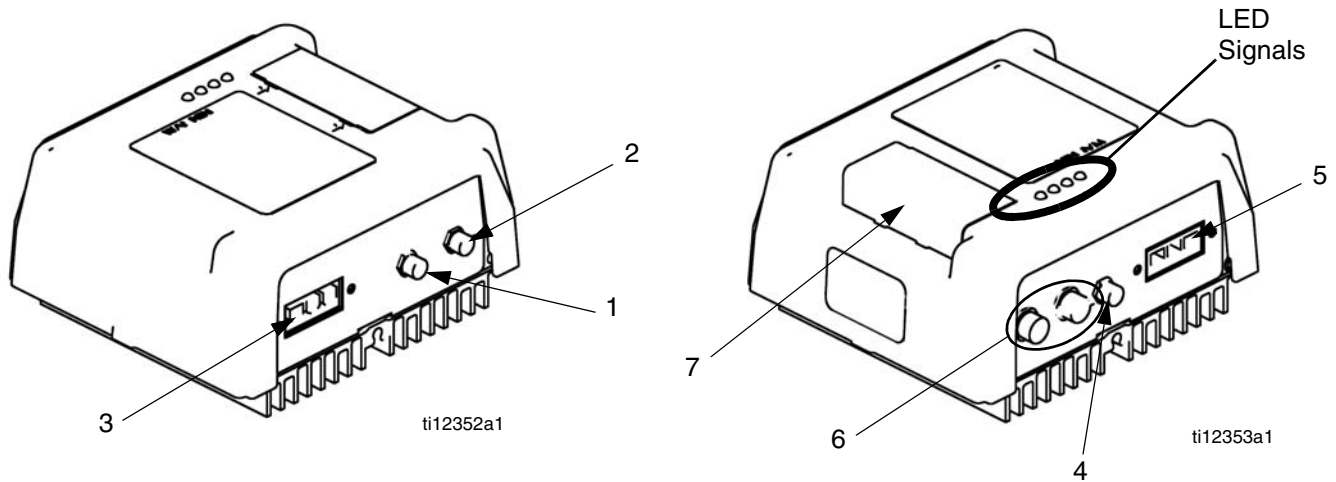

FIG. 9: High Power Temperature Control Module Sensor Connections

Key:

- | | |
|--|--|
| 1 Overtemperature Switch Connection (primary heaters only) | 4 DC Output Connection |
| 2 RTD Temperature Sensor Connection | 5 Input Power Connection |
| 3 Output Power Connection | 6 CAN Connections |
| | 7 Rotary Selector Switch, Token Access |

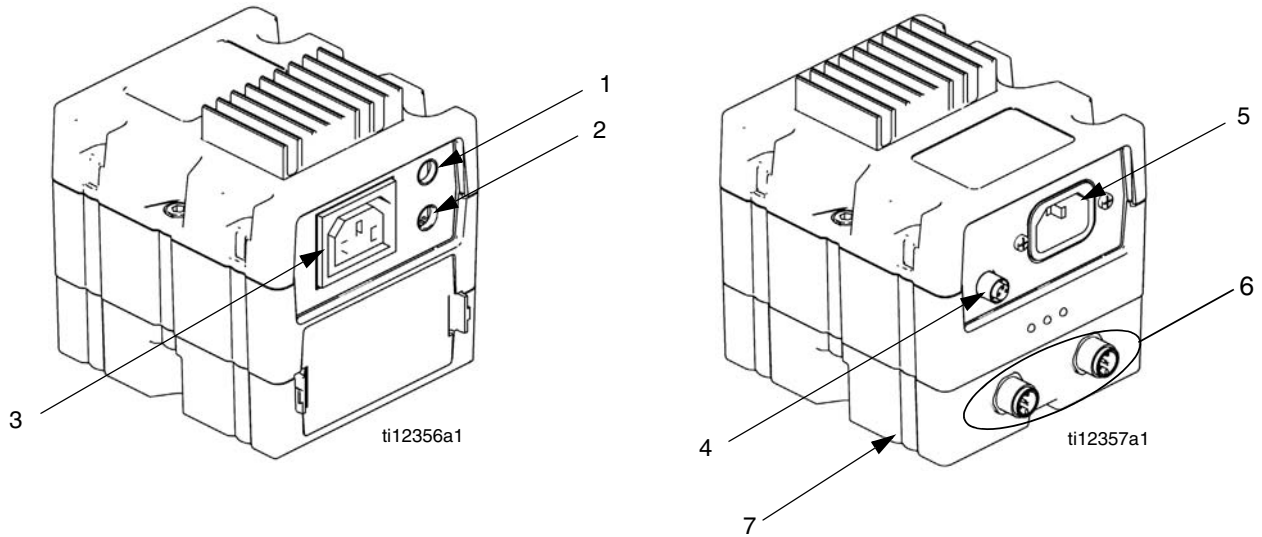

FIG. 10: Low Power Module Cable Connections

- | | |
|-------------------------------------|--------------------------|
| 1 Overtemperature Switch Connection | 4 DC Output Connection |
| 2 RTD Temperature Sensor Connection | 5 Input Power Connection |
| 3 Output Power Connection | 6 CAN Connections |
| | 7 Base |

Heat Control Zone Selection (Heated models only)

The HFR unit supports 4 independent temperature control zones. The high power temperature control modules are located inside the frame below the hydraulic power pack.

Hose Heater B (Blue) *Primary Heater B (Blue)*

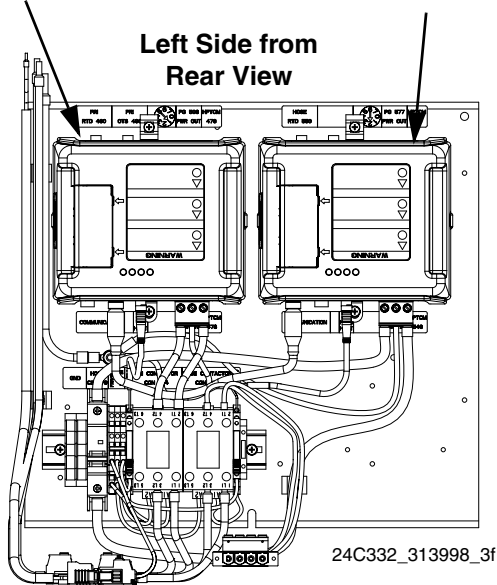

Primary Heater A (Red) *Hose Heater A (Red)*

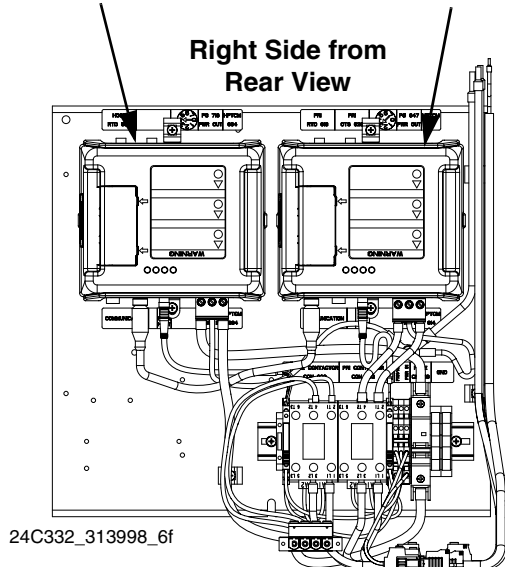

Adjust Rotary Switch

The rotary switch setting indicates which zone the temperature control module will control in the system. The high power module uses an 8-position rotary switch. The low power module uses a 16-position rotary switch.

Set the rotary switch (S) to the specific selection according to the settings listed in the following tables.

High Power Module Rotary Switch Location

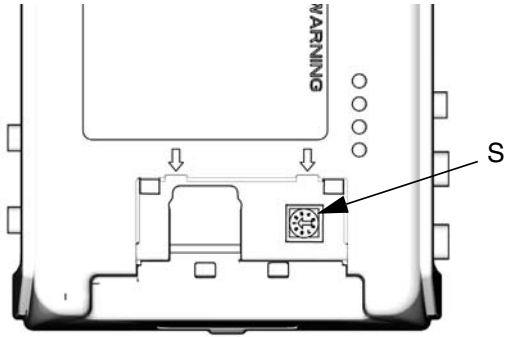

ti12360a

Low Power Module Rotary Switch Location

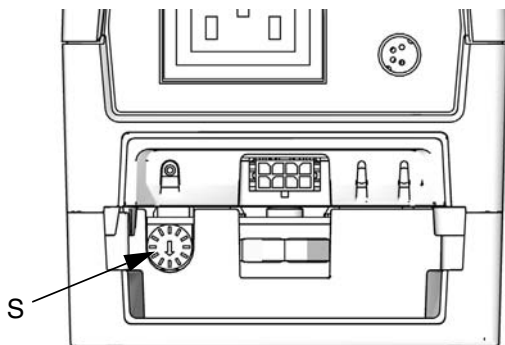

ti12361a

High Power Module Rotary Switch Settings

Setting	Zone
0	Not Used
1	B (Blue) Primary Heat
2	B (Blue) Hose Heat
3	A (Red) Primary Heat
4	A (Red) Hose Heat
5	Not Used
6	Not Used
7	Not Used

Low Power Module Rotary Switch Settings

Setting	Zone
0	Not Used
1	Not Used
2	Not Used
3	Not Used
4	Not Used
5	B (Blue) Tank Heater
6	A (Red) Tank Heater
7	B (Blue) Chiller
8	A (Red) Chiller
9	Not Used
A	Not Used
B	Not Used
C	Not Used
D	Not Used
E	Not Used
F	Not Used

FIG. 11

Dispense Valves Overview

Three types of dispense valves can be used with the HFR system:

- Stall-at-pressure
- Solenoid controlled
- Hydraulically actuated and recirculating

The P2 Gun and Fusion Gun are examples of stall-at-pressure dispense valves. When not dispensing, the fluid in the chemical lines are fully pressurized. When using a stall-to-pressure dispense valve, a foot-switch cannot be used. Any signals sent from a foot-switch will be ignored.

The EP Gun and MD2 Valve are examples of solenoid controlled dispense valves. When the trigger is pulled the signal requests the dispense to start. When the machine sees the signal, fluid rises to dispensing pressure and the valve is opened to begin dispensing. When the trigger is released, the solenoid signals that the dispense is finished.

The L-Head, S-Head, and GX-16 are examples of hydraulically actuated, recirculating dispense valves. When not dispensing, material is recirculated to maintain temperature and pressure. Opening and closing the valve is controlled hydraulically which leads to faster actuation and more accurate dispenses.

Setup

Perform this setup procedure to secure all necessary machine connections for machine operation.

1. Locate HFR.

- a. Locate HFR on a level surface. See **Dimensions** on page 110 for space requirements.
- b. Anchor the HFR to the floor (suggested anchors: McMaster Carr anchor, 92403A400). See **Dimensions**, page 110, for bolt locations. If machine mobility is required, purchase Mobile Pallet Base with Casters Kit, 24P090.

NOTICE

To avoid tipping the machine and personal injury, do not attach wheels directly to the standard HFR mounting brackets.

- c. Do not expose HFR to rain.

NOTICE

Bolt HFR to original shipping pallet before lifting.

2. Electrical requirements. See Models on page 4 for detailed electrical requirements information.



Installing this equipment requires access to parts which may cause electric shock or other serious injury if work is not performed properly. Have a qualified electrician connect power and ground to main power switch terminals, see step 3 in this setup procedure. All electrical wiring must be done by a qualified electrician and comply with all local codes and regulations.

3. Connect electrical cord.

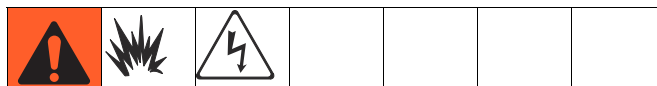

NOTE: See **Power Line Voltage Surges** information on page 39.

NOTE: Power cord is not supplied. See the following table.

Table 1: Power Cord Requirements

Model	Cord Requirements AWG (mm ²)
Non-Heated HFR, 230V, 1 phase	6 (13.3), 2 wire + ground
Non-Heated HFR, 230V, 3 phase	8 (8.4), 3 wire + ground
Non-Heated HFR, 400V, 3 phase	6 (13.3), 4 wire + ground †
Heated HFR, 230V, 1 phase	1 (42.4), 2 wire + ground
Heated HFR, 230V, 3 phase	4 (21.2), 3 wire + ground
Heated HFR, 400V, 3 phase	4 (21.2), 4 wire + ground †

† Residual Current Device (RCD) must be rated at 300 mA if installed.

Electrical Cord Wires by Model

230V, 1 phase: L1, L2, GND

230V, 3 phase: L1, L2, L3, GND

400V, 3 phase: L1, L2, L3, N, GND

Use 5/32 or 4 mm hex allen wrench to connect the two or three power leads to L1, L2, and L3, as applicable. Connect green to ground (GND).

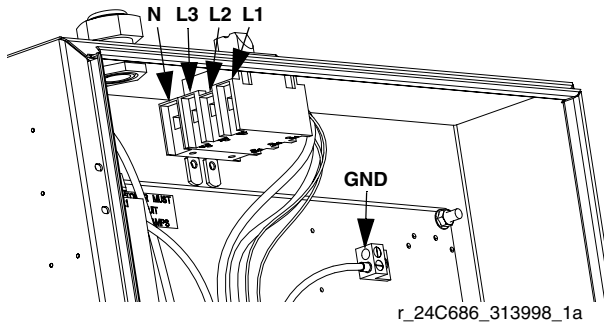

FIG. 12: 400V, 3 phase shown

Power Line Voltage Surges

Power conversion equipment can be sensitive to voltage fluctuations on incoming power. The Motor Control Module falls under the category of power conversion equipment because energy is stored on a capacitive bus and then modulated to control a brushless motor. Engineered design takes this into account and withstands a wide range of conditions, but it is possible for supplied power to occasionally fall outside the tolerable range in industrial plants with high-amperage reactive pulsed loads such as welding equipment. If the tolerable range is exceeded, an overvoltage condition is flagged and the system will shut down in an alarm state to protect itself and alert the user of unstable power. Excessive or repeated overvoltage may permanently damage hardware.

The MAX-HOLD feature on a multimeter can be used to determine peak DC voltage on the line. DC is the proper setting, as opposed to AC, because peak voltage is the critical parameter that affects the DC voltage level stored on the capacitive bus in power conversion equipment. Reading should not regularly exceed approximately 400VDC to avoid tripping the 420VDC alarm level in the Motor Control Module. If power quality is suspect, power conditioning or isolation of the device(s) causing poor power quality is recommended. Consult a qualified electrician if there are any concerns about the available power supply.

Power Line Test Steps with Multimeter

- a. Set multimeter to “DC voltage”.
- b. Connect multimeter probes to supplied power line.

- c. Press “Min Max” successively to show the peak positive and negative DC voltages.
- d. Confirm readings do not exceed 400VDC (Motor Control Module alarm issued at 420VDC).

The chart below shows the permissible magnitude and duration of temporary over-voltage events:

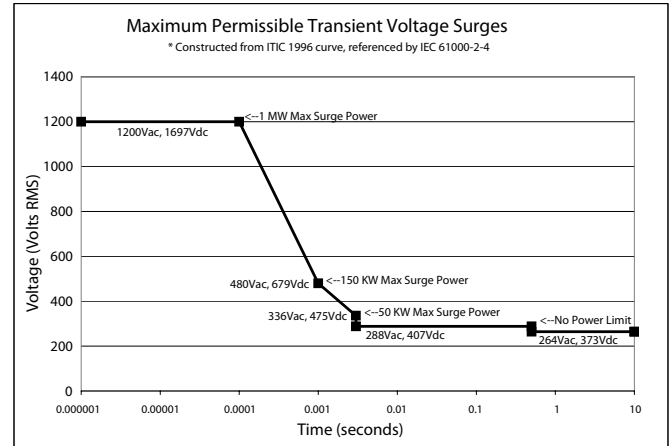

4. Connect feed lines

- a. Install feed pumps (K) in component A (Red) and B (Blue) supply drums. See FIG. 1 and FIG. 2, pages 23 and 25.

NOTE: A minimum feed pressure of 50 psi (0.35 MPa, 3.5 bar) is required at both feed inlet pressure gauges (FP). Maximum feed pressure is 250 psi (1.75 MPa, 17.5 bar). Maintain A (Red) and B (Blue) feed pressures within 10% of each other.

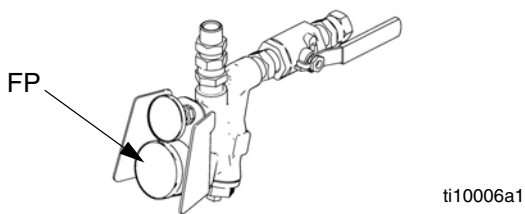

- b. Seal component A (Red) drum and use desiccant dryer (M) in vent.
- c. Install agitator (L) in component B (Blue) drum, if necessary.
- d. Ensure A (Red) and B (Blue) inlet valves (FV) are closed.

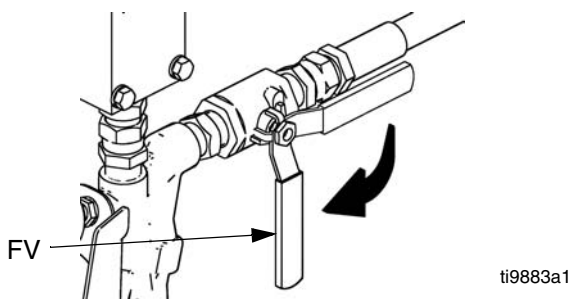

NOTE:

Supply hoses from feed pumps should be 3/4 in. (19 mm) ID minimum.

- e. Connect and tighten component B (Blue) supply hose to the 3/4 npt(f) swivel on the component B (Blue) inlet valve.
- f. Connect and tighten component A (Red) supply hose to the 1/2 npt(f) swivel on the component A (Red) inlet valve.

5. Connect pressure relief lines

<p>Do not install shutoffs downstream of the PRESSURE RELIEF/DISPENSE valve outlets (BA, BB). The valves function as overpressure relief valves when set to DISPENSE . Lines must be open so valves can automatically relieve pressure when machine is operating. If circulating fluid back to the supply drums, use high pressure hose rated to withstand the maximum working pressure of this equipment.</p>					

- a. **Recommended:** Connect high pressure hose (R) to relief fittings (BA, BB) of both PRESSURE RELIEF/DISPENSE valves. Route hose back to component A (Red) and B (Blue) drums. See FIG. 1, page 23.

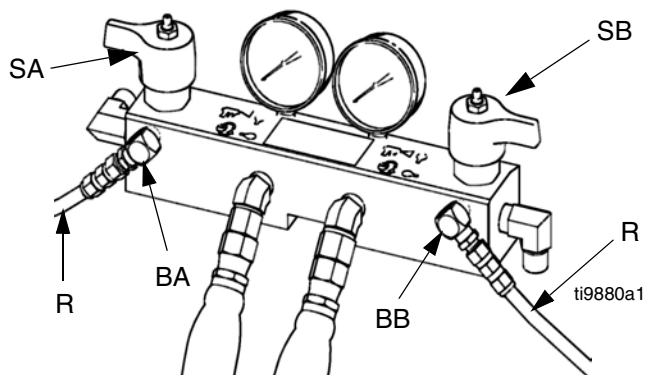

- b. **Alternately:** Secure supplied bleed tubes (N) in grounded, sealed waste containers (H). See FIG. 1, page 23.

6. For Heated HFR models only, install Fluid Temperature Sensor (FTS)

- a. Install FTS between main hose and whip hose. See Heated Hose manual for instructions.

7. Connect heated hose monitor zones

NOTE: For Heated HFR models only, see Heated Hose manual for detailed instructions on connecting heated hoses.

NOTICE

For Heated HFR models only, the FTS (C) and whip hose (D) must be used with heated hose. See step 6 on page 40 for FTS installation. Hose length, including whip hose, must be 10 ft (3 m) minimum.

- a. Turn main power OFF



- b. **For Heated HFR Models only**, assemble heated hose sections, FTS, and whip hose. See Heated Hose manual 3A0237 for heated hose connection details and illustrations for the various types of heated hoses.

For Non-Heated HFR Models only, assemble fluid supply hose sections and whip hose.

- c. Connect A (Red) and B (Blue) hoses to A (Red) and B (Blue) outlets on HFR fluid manifold (FM). Hoses are color coded: red for component A, blue for component B. Fittings are sized to prevent connection errors.

NOTE: Gun fluid manifold hose adapters allow use of 1/4 in. and 3/8 in. ID fluid hoses. To use 1/2 in. (13 mm) ID fluid hoses, remove adapters from gun fluid manifold and install as needed to connect hose.

- d. **For Heated HFR Models only**, connect cables (Y). Connect electrical connectors (V). Be sure cables have slack when hose bends. Wrap cable and electrical connections with electrical tape. See Heated Hose manual for heated hose connection details and illustrations for the various types of heated hoses.

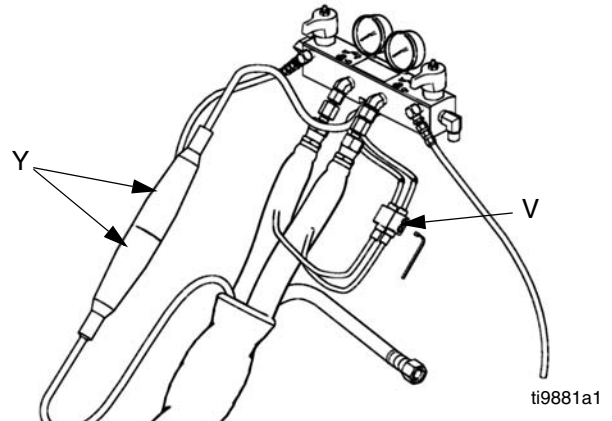

8. **For systems with a gun fluid manifold, close gun fluid manifold valves A (Red) and B (blue).**

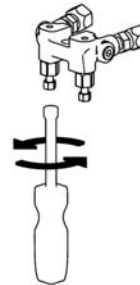

9. For models with an MD2 valve, connect whip hose to MD2 valve component A (Red) and component B (Blue) fluid inlets.

For models with a dispense gun, connect whip hose to gun fluid manifold. Do not connect manifold to gun. See FIG. 13.

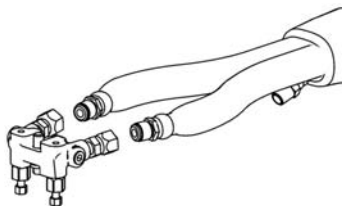

ti2417a1

FIG. 13

10. Pressure check hose

See hose manual. Pressure check for leaks. If no leaks, wrap hose and electrical connections to protect from damage.

11. Ground system

This equipment must be grounded.						

- HFR*: grounded through power cord. See step 3 on page 38.
- EP Gun or Dispense Valve*: If supplied, connect whip hose ground wire to FTS, see step 6 on page 40. Do not disconnect wire or dispense without whip hose.
- Fluid supply containers*: follow your local code.
- Object being dispensed*: follow your local code.
- Solvent pails used when flushing*: follow your local code. Use only metal pails, which are conductive, placed on a grounded surface. Do not place pail on a nonconductive surface, such as paper or cardboard, which interrupts grounding continuity.
- To maintain grounding continuity when flushing or relieving pressure*, hold a metal part of dis-

pense gun firmly to the side of a grounded metal pail, then trigger gun.

12. Check hydraulic fluid level

Hydraulic reservoir is filled at the factory. Check fluid level before operating the first time, and weekly thereafter. See **Technical Data** on page 108 for specifications.

13. IsoGuard Select Fluid system setup

Component A (Red) Pump: Fill IsoGuard Select reservoir (LR) with IsoGuard Select fluid (24F516).

- Lift the reservoir (LR) out of the bracket (RB) and remove the container from the cap.

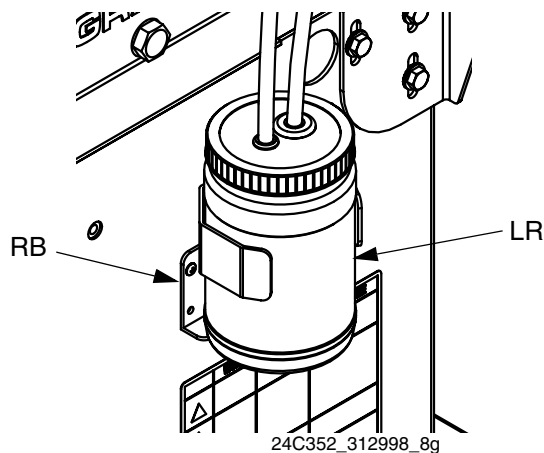

- Fill with fresh fluid. Thread the reservoir onto the cap assembly and place it in the bracket (RB).
- Push the supply tube approximately 1/3 of the way into the reservoir. The supply tube is the tube with the check valve with an arrow pointing in the direction of flow towards the IsoGuard Select fluid cylinder.
- Push the return tube into the reservoir until it reaches the bottom. The return tube is the tube with the check valve with an arrow pointing in the direction of flow away from the IsoGuard Select fluid cylinder.

NOTE: The return tube must reach the bottom of the reservoir to ensure that isocyanate crystals will settle to the bottom and not be siphoned into the supply tube and returned to the pump.

14. Prime IsoGuard Select fluid cylinder

The IsoGuard Select fluid cylinder must be primed when replacing IsoGuard Select fluid. See **IsoGuard Select® System** on page 57 for instructions.

15. Install dispense valve



- Navigate to System Screen 2 and select the appropriate dispense valve from the “Dispense Valve” dropdown menu. See **System Screen 2** on page 73.
- Set pressure relief valves (SA, SB) to RELIEF.
- If dispense valve has a trigger safety lock, engage the trigger safety lock.



LOCKED

ti10442a1

- Connect gun to machine. Verify gun is ready for operation. See appropriate gun manual listed in **Related Manuals** on page 3 for detailed instructions.
- If gun has pneumatics, verify air line is connected then open bleed-type master air line valve.
- Set PRESSURE RELIEF/DISPENSE valves (SA, SB) to DISPENSE

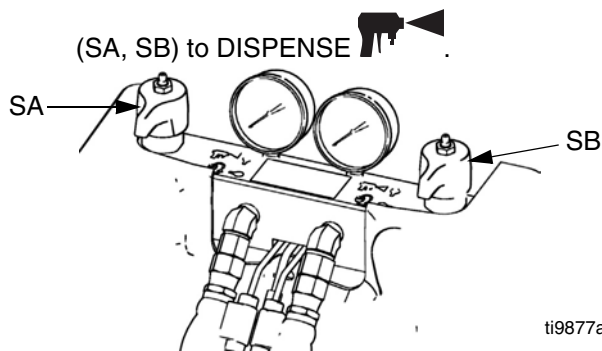

ti9877a1

- Press  to enable system. LED should be solid green.
- Check that heat zones are on and temperatures are on target, see **Status Screen** on page 85.
- Check fluid pressure display and adjust as necessary.
- For MD2 and Auto-Fusion dispense valves, perform Connect Solenoid Kit procedure. See Heated Hoses and Applicator Kits manual for procedure.
- Check fluid pressure gauges (GA, GB) to ensure proper pressure balance. If imbalanced, reduce pressure of higher component by **slightly** turning PRESSURE RELIEF/DISPENSE valve for that component toward PRES-

SURE RELIEF/CIRCULATION , until gauges show balanced pressures.

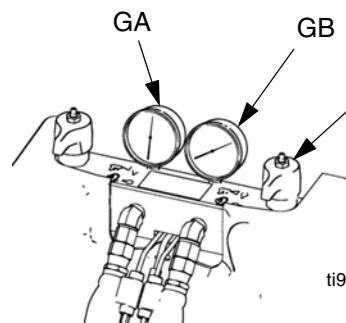

In this example, B (Blue) side pressure is higher, so use the B (Blue) side valve to balance pressures.

ti9877a1

- For MD2 and Auto-Fusion dispense valves, perform Connect Solenoid Kit procedure. See Heated Hoses and Applicator Kits manual for procedure.
- If dispense valve has a trigger safety lock, disengage the trigger safety lock.



UNLOCKED

ti10441a1

- n. For EP Gun and GX-16, perform a test pour into a waste container. Adjust pressure and temperature to get desired results. Equipment is ready to dispense.
- o. For all dispense valves other than the EP Gun, perform mix ratio test using two tared cups. Weigh the cups and divide the weights to verify the mix ratio by weight. See Ratio Checking section in the dispense valve manual for more information.
- p. For Fusion dispense valves, perform DC Power Pack Hydraulic Pressure Setup. See HFR Repair manual for procedure.
- q. Equipment is ready to dispense.

Vacuum De-gas



NOTE: This procedure is for assemblies with vacuum tree manifold and no agitator or auto-refill.

1. Disable machine movement by pressing the Machine Disable Mode key ().
2. Close the shut-off ball valves at the base of the tanks.
3. If the tank lid has a fill port, turn off any systems that might refill the tank during the vacuum de-gas procedure.
4. Close the fill port ball valve.
5. If the tank lid requires a desiccant dryer or nitrogen pump installed, install one into the top ball valve of the vacuum tree manifold.
6. Close the top ball valve of the vacuum tree manifold.
7. Attach vacuum pump to the bottom ball valve of the vacuum tree manifold then open the ball valve.
8. Turn on the vacuum pump.
9. Continue to de-gas for sufficient time to de-gas the material.
10. Close bottom ball valve of the vacuum tree manifold.
11. Turn off the vacuum pump.
12. Open the top ball valve of the vacuum tree manifold.





NOTICE

Operating the tank after the vacuum de-gas procedure without the top ball valve open will result in pump cavitation, off-ratio conditions, and possible collapse of the tank.

13. Open the shutoff valves at the base of the tanks.

Vacuum De-gas and Vacuum Manual Refill

NOTE: This procedure is for assemblies with a vacuum tree manifold, agitator, and auto-refill.

1. Press the Select Operating Mode button () repeatedly to select Shot, Sequence, or Operator (Manual) mode.
2. Close the shut-off ball valves at the base of the tanks.
3. If the tank lid requires a desiccant dryer or nitrogen pump installed, install one into the top ball valve of the vacuum tree manifold).
4. Close the top ball valve of the vacuum tree manifold.
5. Attach vacuum pump to the bottom ball valve of the vacuum tree manifold then open the ball valve.
6. Turn on the vacuum pump.
7. Turn on agitator.
8. Select Manual Refill mode. See operation manual referenced at the beginning of this manual for more information.
9. Press the appropriate Auto-Refill Tank Select button or buttons ( and/or ) to select the tanks to refill.
10. If necessary, press the Abort/Cancel button () to cancel auto-refill.

 If an auto-refill is aborted or times out, the software will not initiate a new auto-refill until a manually initiated auto-refill has completed. To complete a manually initiated auto-refill after an aborted or timed out auto-refill, restart at step 2.

NOTICE

If an auto-refill is stopped and not restarted as described in the previous note, the pumps may be run dry and chemical crossover at the valve may occur.

11. Continue to de-gas for sufficient time to de-gas the material.

12. Close bottom ball valve of the vacuum tree manifold).
13. Turn off the vacuum pump.
14. Open the top ball valve of the vacuum tree manifold.

NOTICE

Operating the tank after the vacuum de-gas procedure without the top ball valve open will result in pump cavitation, off-ratio conditions, and possible collapse of the tank.

15. Open the shutoff valves at the base of the tanks.

Advanced Display Module (ADM) Operation

When main power is turned on by turning the main power switch (MP) to the ON position, the splash screen will be displayed until communication and initialization is complete.



To begin using the ADM, the machine must be on and enabled. To verify the machine is enabled, verify the System Status Indicator Light (CB) is illuminated green, see FIG. 5 on page 30. If the System Status Indicator Light is not green, press the ADM Power On/Off (CA)

button . The System Status Indicator Light will illuminate yellow if the machine is disabled.

If the machine is in the Disabled mode screen press



repeatedly to select a different operating mode.

Perform the following tasks to fully setup your system.

1. Set general system settings. See **Advanced Screen 1**, page 80.
2. Set units of measure. See **Advanced Screen 2**, page 80.
3. Enable/disable system features. See **Advanced Screen 3**, page 80.
4. Define control mode, dispense mode, and pump information. See **System Screen 1**, page 73.
5. Define dispense valve and other system settings. See **System Screen 2**, page 73.
6. Define labels and other system settings. See **System Screen 3**, page 74.
7. **If L-Head is installed**, define L-Head control details. See **Mix Head Operating Details Screen**, page 74.
8. Define level sensors and refill settings. See **Supply Screen**, page 76.
9. Enable/disable temperature conditioning components. See **Conditioning Screen 1**, page 77.
10. Define temperature conditioning setpoints. See **Conditioning Screen 2**, page 77.
11. **If Night mode will be used**, define Night mode settings. See **Conditioning Screen 3**, page 78.
12. Calibrate machine. See **Calibration Screen, Main**, page 72.
13. Define shots. See **Shots Screen**, page 69.
14. Define sequences. See **Sequences Screen**, page 71.
15. If desired, view/reset counters. See **Maintenance Screen**, page 75.

Startup

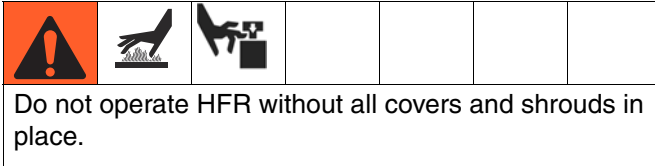

1. Use feed pumps to load fluid

NOTE:

The HFR is tested with oil at the factory. Flush out the oil with a compatible solvent before dispensing. See **Flushing** on page 52.

- Check that all machine connections are setup. See **Setup** procedure, page 38.
- Check that inlet screens are clean before daily startup, see page 56.
- Check level and condition of ISO lube daily, see **IsoGuard Select[®] System** on page 57.
- Turn on component B (Blue) and component A (Red) agitators, if used.
- Turn both PRESSURE RELIEF/DISPENSE

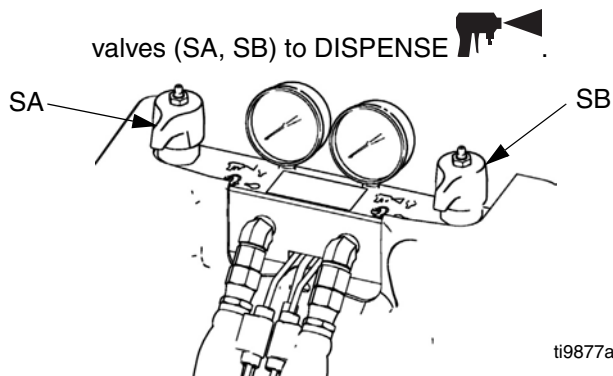

- Start feed pumps.

- Open fluid inlet valves (FV). Check for leaks.

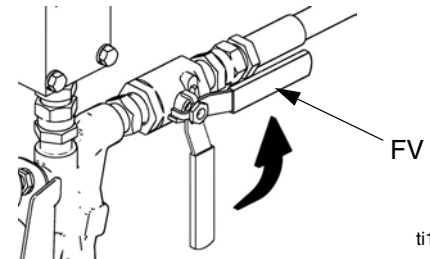

Keep Components A (Red) and B (Blue) Separate						
Cross-contamination can result in cured material in fluid lines which could cause serious injury or damage equipment. To prevent cross-contamination of the equipment's wetted parts, never interchange component A (Red) and component B (Blue) parts.						

- Use feed pumps to load system.
- For models with an EP, Fusion, or P2 gun only**, hold gun fluid manifold over two grounded waste containers. Open gun fluid valves A (Red) and B (Blue) until clean, air-free fluid comes from valves. Close valves.

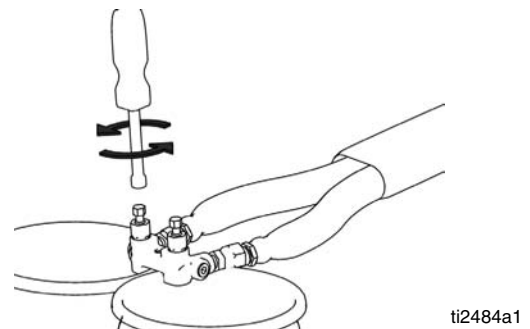

- For models with an MD2 Valve only**, hold MD2 valve nose piece, without a mixer installed, over two grounded waste containers. Leave mixer off and trigger gun until both fluids flow freely from the nose piece without any air.
- To prime the pump, cycle the pump a few times or until air-free fluid dispenses.

2. Calibrate HFR

The HFR calibration procedure is a two step process. The first step, Learn Mode, must be performed whenever the pump line is rebuilt or if any other maintenance is performed that may affect the mechanical tolerances in the pump line. If the machine does not appear to be utilizing the full extent of the pump stroke, or if the machine appears to be contacting the end of the hydraulic cylinder, follow the Learn Mode procedure. The Learn Mode procedure will teach the system the mechanical limits of travel.







Learn Mode Procedure:

- a. Navigate to the Calibration screen.



- b. Press the Learn Mode Calibration button  and set the mode to run as the dispense applicator that is installed on the system.

NOTE: For circulation systems, set the mode as either EP or MD2 valves. These settings will not dispense material.

- c. Place a waste container below the dispense valve. The next steps will cause the machine to dispense material for all other settings.
- d. Press the go right button  and then the dispense button . The pump will travel to the right most extreme position.
- e. After the pump stops moving, press the go left button  and then press the dispense button . The pump will travel to the left most extreme position.
- f. After the pump stops moving, press the continue button  to go on to the next step in the calibration process or the page back button  to return to the main Calibration screen.







NOTE: During this process, the system learned the mechanical limits of travel. If the pump did not reach both the left and right extreme limits for any reason, repeat the procedure.





If the system is to be used in a Time or Volume Dispense Mode, system calibration is complete after the Learn Mode procedure described above. However, if the system is to be used in Weight Dispense mode and the application requires that the dispense amount be accurate and consistent then the weight calibration procedure below must be followed.

Weight Calibration Procedure:

NOTE: Only perform Weight Calibration procedure if the system will be run in Weight Dispense mode.



The Weight Calibration procedure must be run with the system production-ready. Orifice sizes and hose lengths must be finalized, material should be at temperature and any conditioning zones that will be on during production should be turned on. Any variation in system setup between when this procedure is run and the production environment will result in a decrease in system dispense accuracy.

- a. Navigate to the Weight Calibration screen .
- b. Navigate to the Cal. Setpoint text box then enter the desired set point (pressure or flow, based on selected Control Mode).
- c. Press .
- d. Put a waste container under the dispense valve.
- e. Press  or the footswitch to start the system characterization process. The pump will start to operate at the entered setpoint until it learns the proper control parameters, then repeat the process at 60% of that value. When it is complete, the  icon will change back to .
- f. Press  again to deactivate.
- g. Select the Cal. Point 1 of 2 text box under the scale graphic.

- h. With a waste container under the dispense valve, press  or the footswitch to dispense a Cal. 1 shot. Discard the dispensed material.
- i. Select the Cal. 1 Shot Average field then press  to erase the value.
- j. Select the Cal. Point 1 of 2 text box.
- k. Press  or the footswitch to dispense a Cal. 1 shot.
- l. Weight the material dispensed and enter the weight in the text box.
- m. Repeat the previous two steps three more times. The logic will automatically average the readings and provide the result in the second text box in the row.
- n. Select the Cal. Point 2 of 2 text box under the scale graphic.
- o. Press  or the footswitch to dispense a Cal. 2 shot.
- p. Weight the dispensed material and enter the weight in the text box.
- q. Repeat the previous two steps three more times. The logic will automatically average the readings and provide the result in the second text box in the row.
- r. Press .

The system is now able to dispense accurate material amounts for the setpoint provided during the process. If a weight dispense operation uses a setpoint significantly different from the setpoint used in during calibration an advisory will be provided to inform the user that the dispense accuracy may be degraded.

3. Set temperatures (Heated models only)



						
<p>This equipment is used with heated fluid, which can cause equipment surfaces to become very hot. To avoid severe burns:</p> <ul style="list-style-type: none"> • Do not touch hot fluid or equipment. • Allow equipment to cool completely before touching it. • Wear gloves if fluid temperature exceeds 110°F (43°C). 						

For detailed temperature adjustments, including alarm levels, or upon initial machine configuration, see **Conditioning Screen 2** on page 77 for details. For minor adjustments to the temperature setpoint once the machine has been initially configured, see the **Status Screen** on page 85.

4. Set system control and dispense modes: See **System Screen 1** on page 73.

5. Set pump sizes: See **System Screen 1** on page 73.



6. Define Shot Recipes

- a. Navigate to the Shots screen.
- b. Press  to enter the screen.
- c. Use the directional keypad to navigate to the shot detail column for the desired shot number.
- d. Type the desired setting for that item then press .
- e. Repeat the previous two steps for all desired shot numbers.

7. Change pressure imbalance setting (optional)

The pressure imbalance function detects conditions that can cause off-ratio dispense, such as loss of feed pressure/supply, pump seal failure, clogged fluid inlet filter, or a fluid leak.



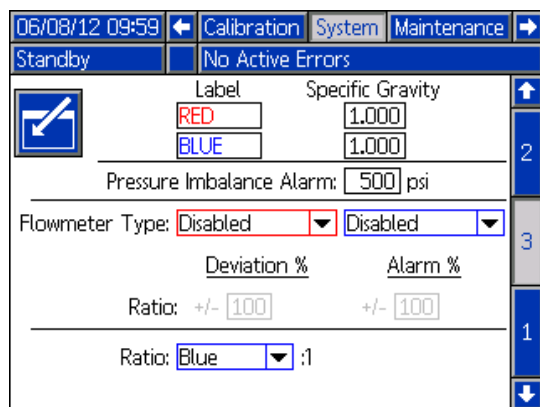

The pressure imbalance default is factory-set at 500 psi (3.5 MPa, 35 bar). For tighter ratio error detection, select a lower value. For looser detection or to avoid nuisance alarms, input a higher value.

- a. Navigate to System Screen 3.
- b. Press  to enter the screen.
- c. Navigate to the pressure imbalance field.
- d. Type the desired pressure imbalance setting then press Enter .



Shutdown



1. Park pumps.
 - a. From the Home screen, press  and select Standby mode.
 - b. Press . Material will dispense for non circulation systems. Pump will park automatically. Once pump is parked, pump will stop moving. **If a dispense gun with a trigger is installed, pulling the trigger will begin a park operation. Material will dispense for non circulation systems.**
 - c. **For models with an EP, Fusion, or P2 gun only,** turn diversion valves to tank then press . Pressure must be below 400 psi (2.8 MPa, 28 bar).
2. Press the enable/disable key on the ADM  to disable the ADM.
3. Turn main power switch (MP) to OFF position.
4. Close A (Red) and B (Blue) fluid supply valves (FV).

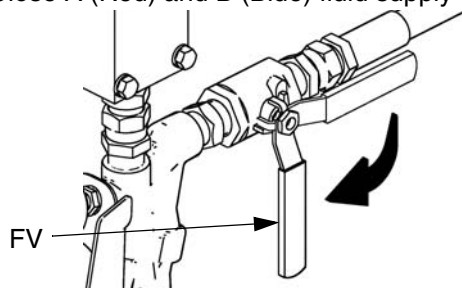

ti9883a1

5. Perform **Pressure Relief Procedure** on page 51.
6. Shut down feed pumps as required. See feed pump manual.

Pressure Relief Procedure



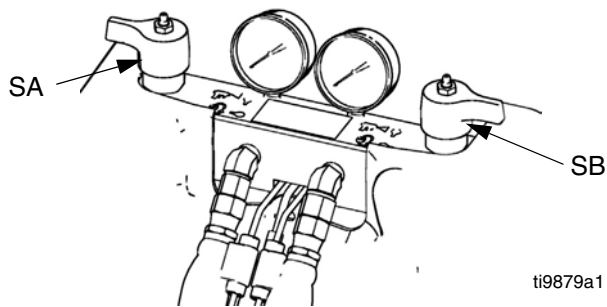

1. Shut off feed pumps and agitator, if used.
2. Turn PRESSURE RELIEF/DISPENSE valves (SA,

SB) to PRESSURE RELIEF/CIRCULATION . Route fluid to waste containers or supply tanks. Ensure gauges drop to 0.



3. **For models with an dispense valve with a safety lock, engage gun safety lock.**
4. Relieve pressure in dispense valve. See dispense valve manual.

Flushing

						
Flush equipment only in a well-ventilated area. Do not dispense flammable fluids. Do not turn on heaters while flushing with flammable solvents.						

- To maintain grounding continuity when flushing or relieving pressure, hold a metal part of dispense gun firmly to the side of a grounded *metal* pail, then trigger gun.

- Flush out old fluid with new fluid, or flush out old fluid with a compatible solvent before introducing new fluid.
- Use the lowest possible pressure when flushing.
- All fluid components are compatible with common solvents. Use only moisture-free solvents. See **Technical Data** on page 108 for list of wetted components to verify compatibility of solvent with wetted materials. See solvent manufacturers information for material compatibility.
- To flush feed hoses, pumps, and heaters separately from heated hoses, set PRESSURE RELIEF/DIS-PENSE valves (SA, SB) to PRESSURE

RELIEF/CIRCULATION  . Flush through bleed lines (N).

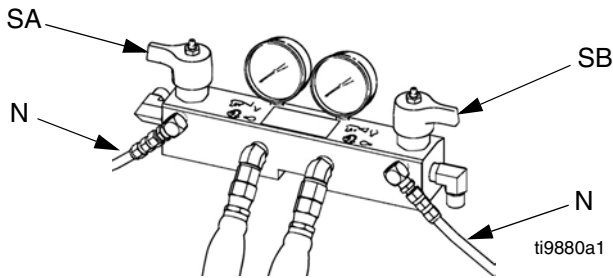

- To flush entire system, circulate through gun fluid manifold (with manifold removed from gun).
- To prevent moisture from reacting with isocyanate, always leave the system dry or filled with a moisture-free plasticizer or oil. Do not use water. See **Important Two-Component Material Information** on page 20.
- *Solvent pails used when flushing:* follow your local code. Use only metal pails, which are conductive, placed on a grounded surface. Do not place pail on a nonconductive surface, such as paper or cardboard, which interrupts grounding continuity.

Maintenance



Task	Schedule
Change break-in oil in a new unit	After first 250 hours of operation or within 3 months, whichever comes first
Inspect hydraulic and fluid lines for leaks	Daily
Inspect fluid inlet strainer screens, page 56	Daily
Inspect IsoGuard Select fluid level and condition, refill or replace as needed, page 57	Daily
Check hydraulic fluid level	Weekly
Grease circulation valves with Fusion grease (117773)	Weekly
Verify operation of air drying system to prevent isocyanate crystallization	Weekly
Verify vent holes on bottom of electrical cabinet are clear and unobstructed	Weekly
Inspect air filter (part 24H018), clean or replace as necessary,	Daily
Use compressed air to remove dust buildup on control boards, fan, motor (under shield), and hydraulic oil coolers	Monthly
Clean up all hydraulic leaks; identify and repair cause of leak	As needed
Clean dispense valve mix chamber ports regularly, see dispense valve manual	See dispense valve manual
Clean dispense valve check valve screens, see dispense valve manual	See dispense valve manual

Change Break-in Oil

After initial break-in, see Table 5 for recommended frequency of oil changes.

Table 2: Frequency of Oil Changes

Ambient Temperature	Recommended Frequency
0 to 90°F (-17 to 32°C)	1000 hours or 12 months, whichever comes first
90°F and above (32°C and above)	500 hours or 6 months, whichever comes first

Grease Circulation Valves With Fusion Grease (117773)

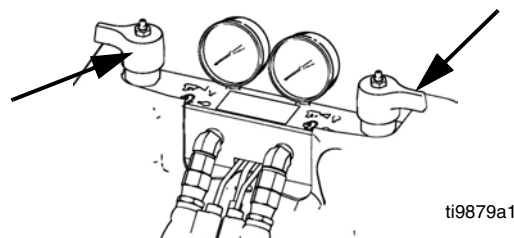

Check Hydraulic Fluid Level

Check hydraulic fluid level on dipstick (DS). Fluid level must be between indent marks (IM) on dipstick. Refill as required with approved hydraulic fluid; see **Technical Data** on page 108. If fluid is dark in color, change fluid and filter.

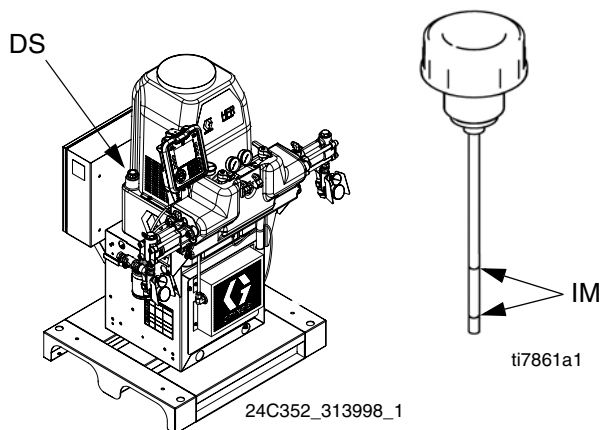

ADM - Battery Replacement and Screen Cleaning



Battery Replacement

A lithium battery maintains the ADM clock when power is not connected.

To replace the battery:

1. Disconnect power to the ADM.

NOTE: This can be done by removing the CAN cable from the bottom of the ADM.

2. Remove rear access panel.

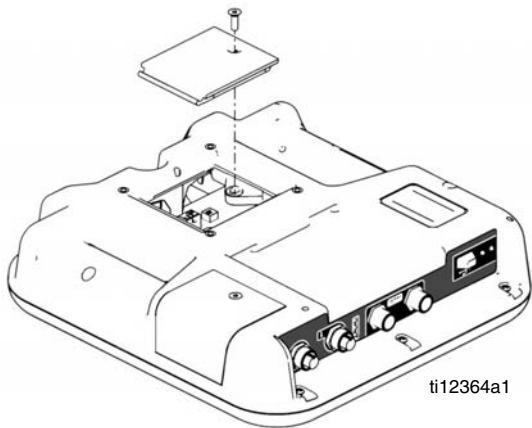

3. Remove the old battery and replace with a new CR2032 battery.
4. Properly dispose the old lithium battery according to local codes.
5. Replace rear access panel.
6. Connect the power to the ADM and reset the clock through **Advanced Screen 1**. Refer to **Appendix B - ADM Setup Screens Overview** for more detail.

Cleaning

Use any alcohol-based household cleaner, such as glass cleaner, to clean the ADM. Spray on the rag then wipe ADM. Do not directly spray the ADM.

MCM and TCM - Clean Heat Sink Fins



Keep heat sink fins clean at all times. Clean them using compressed air.

NOTE: Do not use conductive cleaning solvents on the module.

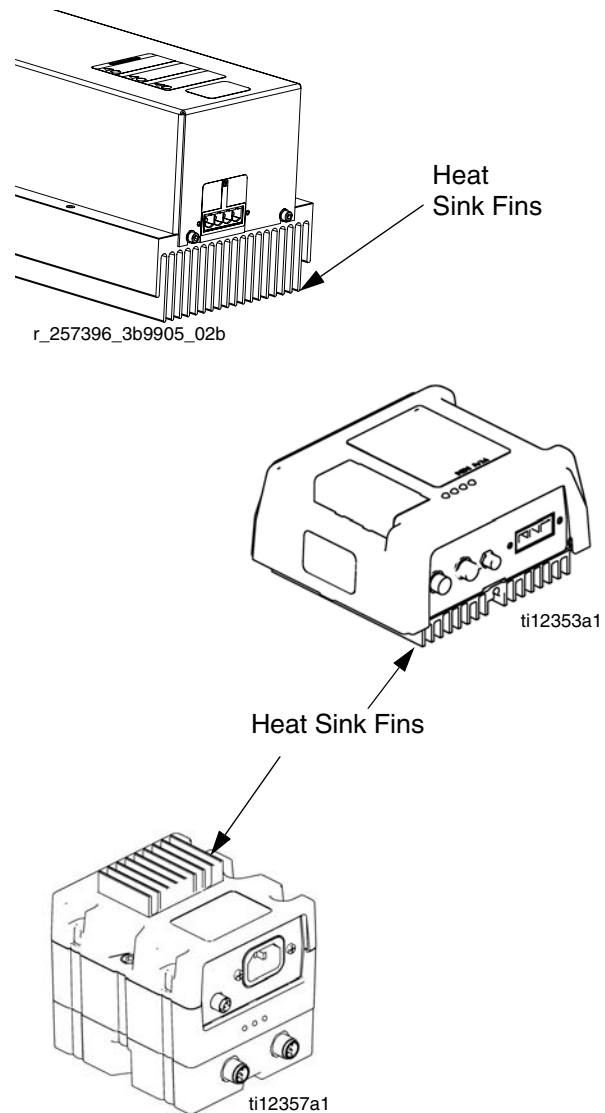

FIG. 14: Clean Heat Sink Fins

Install Upgrade Tokens

NOTE: The Motor Control Module, Fluid Control Module, and Temperature Control Module connection to the system is temporarily disabled during the installation of upgrade tokens.

To install software upgrades:

1. Use correct software token stated in the table. See Graco Control Architecture™ Module Programming manual for instructions.

NOTE: Upgrade all modules in the system to the software version on the token, even if you are replacing only one or two modules. Different software versions may not be compatible.

All data in the module (System Settings, USB Logs, Recipes, Maintenance Counters) may be reset to factory default settings. Download all settings and user preferences to a USB before the upgrade, for ease of restoring them following the upgrade.

See manuals for locations of specific GCA components.

The software version history for each system can be viewed in the technical support section at www.graco.com.

Token	Application
16H821	HFR: - Advanced Display Module - Motor Control Module - High Power Temperature Control Module - Fluid Control Module (AC Power Pack) - Discrete Gateway Module - Communication Gateway Module
16G584	Tank Stand: - Fluid Control Module - Low Power Temperature Control Module
16G407	Ratio Monitoring (Flow Meters): - Fluid Control Module

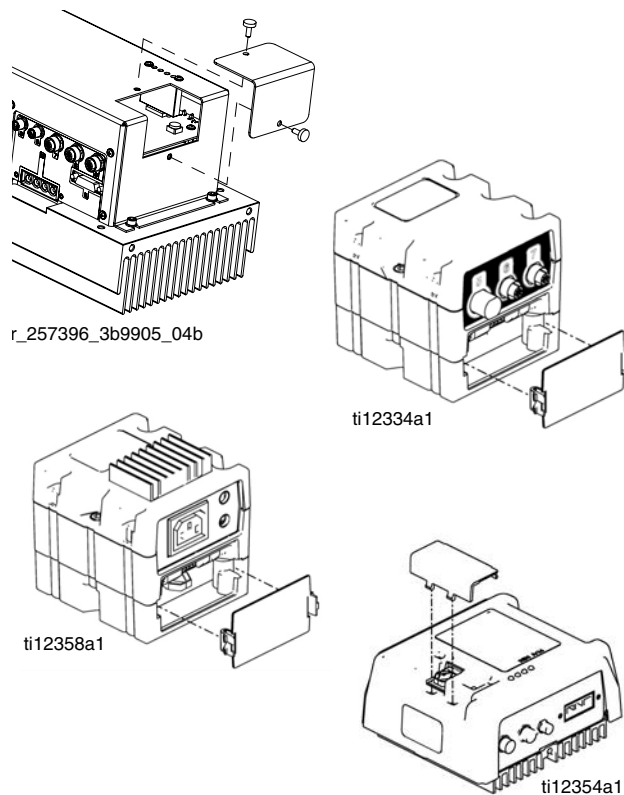

FIG. 15: Remove Access Cover

Fluid Inlet Strainer Screen



The inlet strainers filter out particles that can plug the pump inlet check valves. Inspect the screens daily as part of the startup routine, and clean as required. The standard strainer is 20 mesh.

Use clean chemicals and follow proper storage, transfer, and operating procedures, to minimize contamination of the A-side screen.

NOTE:

Clean the A-side screen only during daily startup. This minimizes moisture contamination by immediately flushing out any isocyanate residue at the start of dispensing operations.

1. Perform **Pressure Relief Procedure** on page 51.
2. Close the fluid inlet valve at the pump inlet and shut off the appropriate feed pump. This prevents material from being pumped while cleaning the screen.
3. Place a container under the strainer manifold (59d) to catch fluid. Remove the strainer plug (59j).
4. Remove the screen (59g) from the strainer manifold. Thoroughly flush the screen with compatible solvent and shake it dry. Inspect the screen. If more than 25% of the mesh is blocked, replace the screen. Inspect the gasket (59h) and replace as required.
5. Ensure the pipe plug (59k) is screwed into the strainer plug (59j). Install the strainer plug with the screen (59g) and gasket (59h) in place and tighten. Do not overtighten. Let the gasket make the seal.

6. Open the fluid inlet valve, ensure that there are no leaks, and wipe the equipment clean. Proceed with operation.

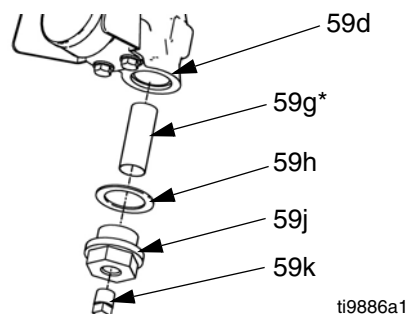

FIG. 16. Fluid Inlet Strainer

IsoGuard Select[®] System



Check the condition of the A (Red) pump IsoGuard Select fluid daily. Change the fluid if it becomes a gel, its color darkens, or it becomes diluted with isocyanate.

Gel formation is due to moisture absorption by the pump IsoGuard Select fluid (24F516). The interval between changes depends on the environment in which the equipment is operating. The pump lubrication system minimizes exposure to moisture, but some contamination is still possible.

Fluid discoloration is due to continual seepage of small amounts of isocyanate past the pump packings during operation. If the packings are operating properly, IsoGuard Select fluid (24F516) replacement due to discoloration should not be necessary more often than every 3 or 4 weeks.

To change pump IsoGuard Select fluid (24F516):

1. Perform **Pressure Relief Procedure** on page 51.
2. Remove fittings from IsoGuard Select fluid cylinder inlet and outlet ports. Keep supply tube (ST), return tube (RT), and leak management tube (LT) connected to the fittings.
3. Carefully place ends of tubes with fittings still connected into an empty pail to drain IsoGuard Select fluid.
4. Lift the IsoGuard Select fluid reservoir (LR) out of the bracket (RB) and remove the container from the cap. Holding the cap over a suitable container, remove the inlet check valve and allow the IsoGuard Select fluid to drain. Reattach the check valve to the inlet hose. See FIG. 17.
5. Drain the reservoir and flush it with clean IsoGuard Select fluid (24F516).
6. When the reservoir is flushed clean, fill with fresh IsoGuard Select fluid (24F516).
7. Thread the reservoir onto the cap assembly and place it in the bracket (RB).
8. Push the supply tube (ST) approximately 1/3 of the way into the reservoir.

9. Push the return tube (RT) into the reservoir until it reaches the bottom.

NOTE:

The return tube must reach the bottom of the reservoir, to ensure that isocyanate crystals will settle to the bottom and not be siphoned into the supply tube and returned to the pump.

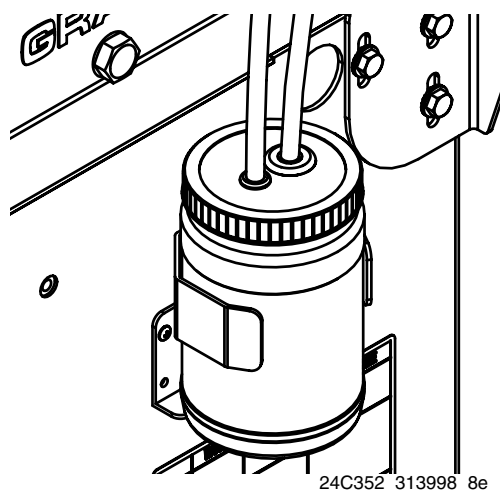

FIG. 17: IsoGuard Select Fluid System

Prime IsoGuard Select Fluid Cylinder

Ensure that the IsoGuard Select fluid cylinder outlet faces upward for air to exhaust.

1. Install IsoGuard Select fluid cylinder inlet fitting and inlet tube into bottom of cylinder. The inlet tube is the tube with a check valve installed in it which points in the direction of flow towards the IsoGuard Select fluid cylinder.
2. Install IsoGuard Select fluid cylinder outlet fitting and outlet tube into top of cylinder. The outlet tube is the tube with a check valve installed in it which points in the direction of flow away from the IsoGuard Select fluid cylinder.
3. Remove check valve from end of outlet tube.
4. Use funnel to pour IsoGuard Select fluid (24F516) into tube to fill cylinder.
5. With check valve arrow pointing away from the IsoGuard Select fluid cylinder, install check valve in end of outlet tube.
6. Install tubes into reservoir and install reservoir into holder.

Troubleshooting



Before performing any troubleshooting procedure:

1. Perform **Pressure Relief Procedure** on page 51.
2. Turn main power OFF.
3. Allow equipment to cool.

Try the recommended solutions in the order given for each problem, to avoid unnecessary repairs. Also, determine that all circuit breakers, switches, and controls are properly set and wiring is correct before assuming there is a problem.

Light Tower (Optional)

Signal	Description
Green on only	System is powered up and there are no error conditions present
Yellow on	An advisory exists
Red flashing	A deviation exists
Red on	The system is shut down due to an alarm occurring.

Errors include advisories, deviations, or alarms, so green will only be on when none of these occur. A yellow light can be on at the same time as red (flashing or solid on) when an advisory exists at the same time as a deviation or alarm.

Common Problems

Problem	Cause	Solution
General		
Display Module completely dark	No Power	Verify AC Power switch is ON
	Thrown Breaker	Check Machines Breakers and Reset
	Loose Connection	Tighten 5-pin cable on Advanced Display Module
	Bad Display Module	Replace Advanced Display Module
No or incorrect amount of material dispensed from either side	Ball Valve closed (if Installed)	Open tank ball valve.
	Tank Empty	Add fluid
	Tank Clogged	Clean tank
	Air In Material	Prime the machine
Significant material leaking from pump seal	Pump shaft worn and/or shaft seal worn	Remove pump shaft assembly and reinstall read pump rebuild kit
Material dispensed not correct weight	Specific gravity of one or more of the two materials has changed since calibration	Run calibration
	Check valve malfunction	Remove check valve; clean or replace as necessary
	Piston worn or broken	Replace Piston
A (Red) and B (Blue) Primary Heaters		
Control of primary heat is abnormal; high temperature overshoots	Dirty RTD connection	Unplug and re-plug RTD wires.
	RTD not contacting heater element	Loosen ferrule nut, push in RTD so tip contact heater element. Holding RTD tip against heater element, tighten ferrule nut 1/4 turn past tight.
	Failed heater element	Replace
	Signal failure from RTD	Check connections
	RTD wired incorrectly	Check connections. Power up zones one at a time and verify that temperature for each zone rises.

Problem	Cause	Solution
Hose Heat System		
Hose heats but heats slower than usual or it does not reach temperature	Ambient temperature is too cold	Use auxiliary hose system.
	FTS failed or not installed correctly	Check FTS
	Low supply voltage	Verify line voltage. Low line voltage significantly reduces power available to hose heat system, affecting longer hose lengths.
Hose does not maintain temperature while spraying	A and B setpoints too low	Increase A (Red) and B (Blue) setpoints. Hose is designed to maintain temperature, not to increase it.
	Ambient temperature is too cold	Increase A (Red) and B (Blue) setpoints to increase fluid temperature and keep it steady
	Flow too high	Use smaller mix chamber. Decrease pressure.
	Hose was not fully preheated	Wait for hose to heat to correct temperature before spraying
	Low supply voltage	Verify line voltage. Low line voltage significantly reduces power available to hose heat system, affecting longer hose lengths.
Hose temperature exceeds setpoint	A (Red) and/or B (Blue) primary heaters are overheating material	Check primary heaters for either an RTD problem or a failed element attached to thermocouple
	Faulty RTD connections	Verify that all FTS connections are snug and that pins of connectors are snug and that pins of connects are clean. Examine connection of thermocouples to long green plug on heater control board. Unplug and re-plug RTD wires, cleaning off any debris. Unplug and re-plug long green connector on heater control board.
Erratic hose temperature	Faulty RTD connection	Verify that all FTS connections are snug and that pins of connectors are clean. Examine connection of RTD to long green plug on heater control board. Unplug and re-plug RTD wires, cleaning off any debris. Unplug and re-plug long green connector.
	FTS not installed correctly	FTS should be installed close to end of hose in same environment as gun. Verify FTS installation.
Hose does not heat	FTS failed or is not contacting correctly	Check FTS
	FTS not installed correctly	FTS should be installed close to end of hose in same environment as gun. Verify FTS installation.
	Temperature control alarm	See Appendix D - ADM Error Codes on page 88
Hoses near system are warm, but hoses downstream are cold	Shorted connection or failed hose heating element	With hose heat on and temperature setpoint above displayed hose zone temperature, verify voltage between connectors at each section of hose. Voltage should drop incrementally for each section of hose further from the system. Use safety precautions when hose heat is turned on.
Proportioning System		
Proportioning pump does not hold pressure when stalled	Pump piston or intake valve leaking	<ol style="list-style-type: none"> 1. Observe gauges to determine which pump is losing pressure. 2. Determine in which direction the pump has stalled by observing which directional valve indicator light is on. 3. Repair the valve.

Problem	Cause	Solution
Material imbalance.	Inadequate flow from pump; cavitation	Increase fluid supply to proportioning pump: <ul style="list-style-type: none"> • Use 2:1 supply pump • Use minimum 3/4 in. (19 mm) ID supply hose, as short as practical
		Fluid is too thick. Consult your material supplier for the recommended fluid temperature to maintain a viscosity of 250 to 1500 centipoise.
		Clean inlet strainer screen
	Worn pump inlet valve ball/seat or gasket	
	Pressure relief/circulation valve leaking back to supply	Remove return line and determine if flow is present while in SPRAY mode
Erratic pump movement	Pump cavitation	Feed pump pressure is too low. Adjust pressure to maintain 100 psi (0.7 MPa, 7 bar) minimum.
Pump output low	Obstructed fluid hose or gun; fluid hose ID too small	Open, clear; use hose with larger ID
	Worn piston valve or intake valve in displacement pump	See pump manual
	Inadequate feed pump pressure	Check feed pump pressure and adjust to 100 psi (0.7 MPa, 7 bar) minimum.

ADM Troubleshooting

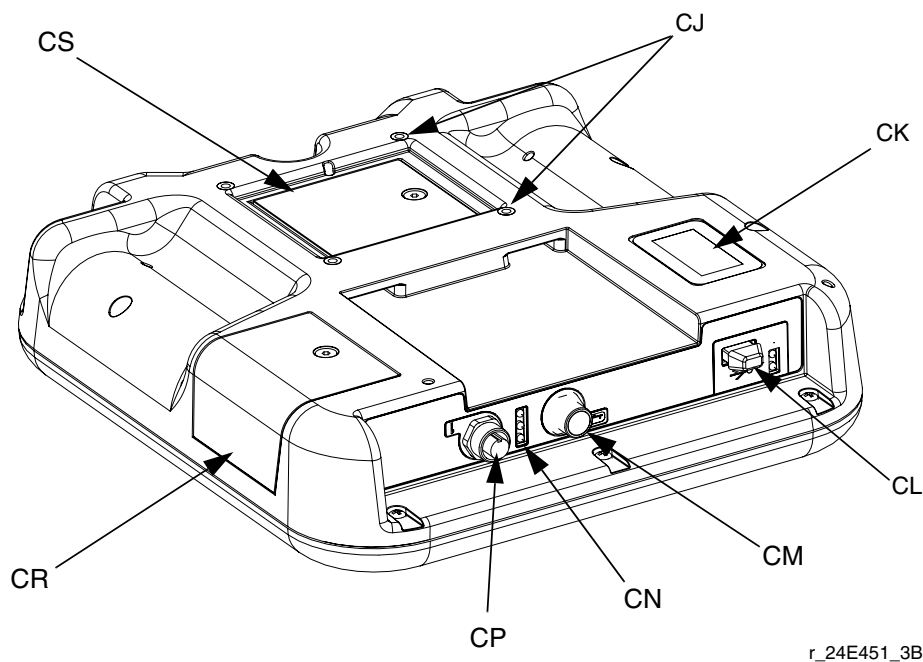

r_24E451_3B9900_1a

FIG. 18: ADM Component Identification - Rear

ADM Module Status LEDs (CN) Conditions

Module Status LED Signal	Description
Green on	System is powered up.
Yellow on	Communication in progress.
Red solid	ADM hardware failure.
Red flashing	Uploading software.

USB Module Status LEDs (CL) Conditions

Module Status LED Signal	Description
Green flashing	System is powered up.
Yellow on	Downloading information to USB
Green/Yellow Flashing	ADM is busy, USB cannot transfer information when in this mode

Motor Control Module

For MCM location, see reference MA in FIG. 2 on page 25.

Diagnostic Information

Table 3: LED Status Signal

Module Status LED Signal	Description
Green on	System is powered up.
Yellow on	Internal communication in progress.
Red solid	MCM hardware failure. Replace MCM.
Red flashing fast	Uploading software.
Red flashing slow	Token error. Remove token and upload software token again.

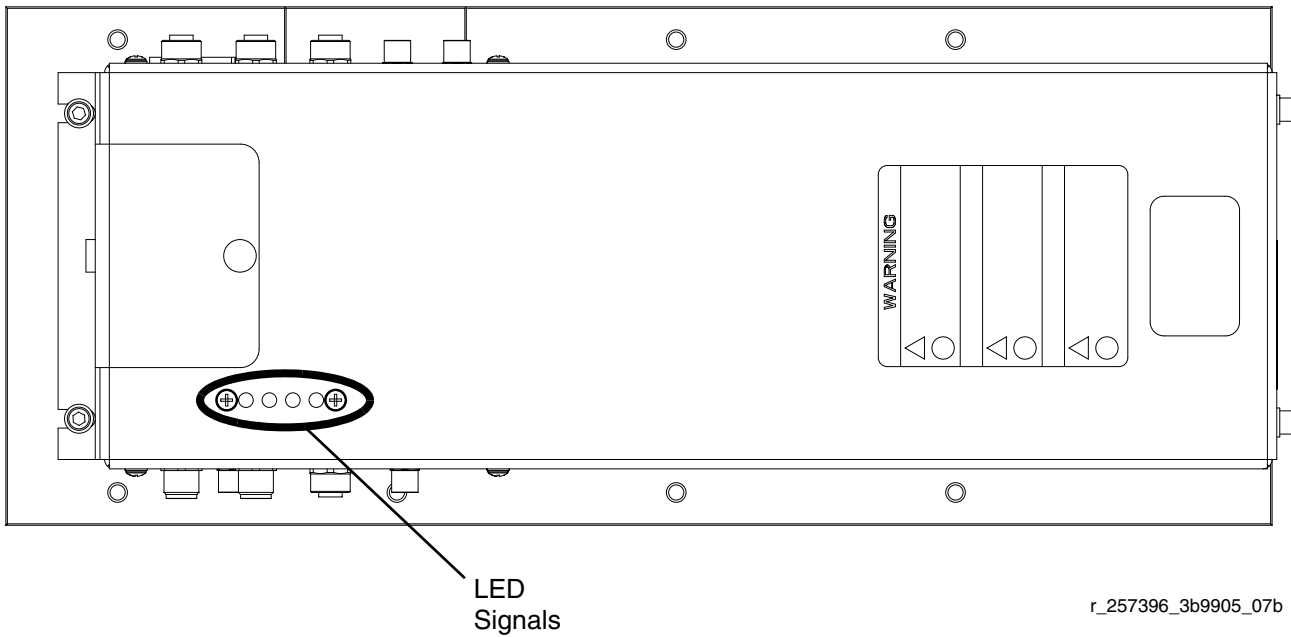
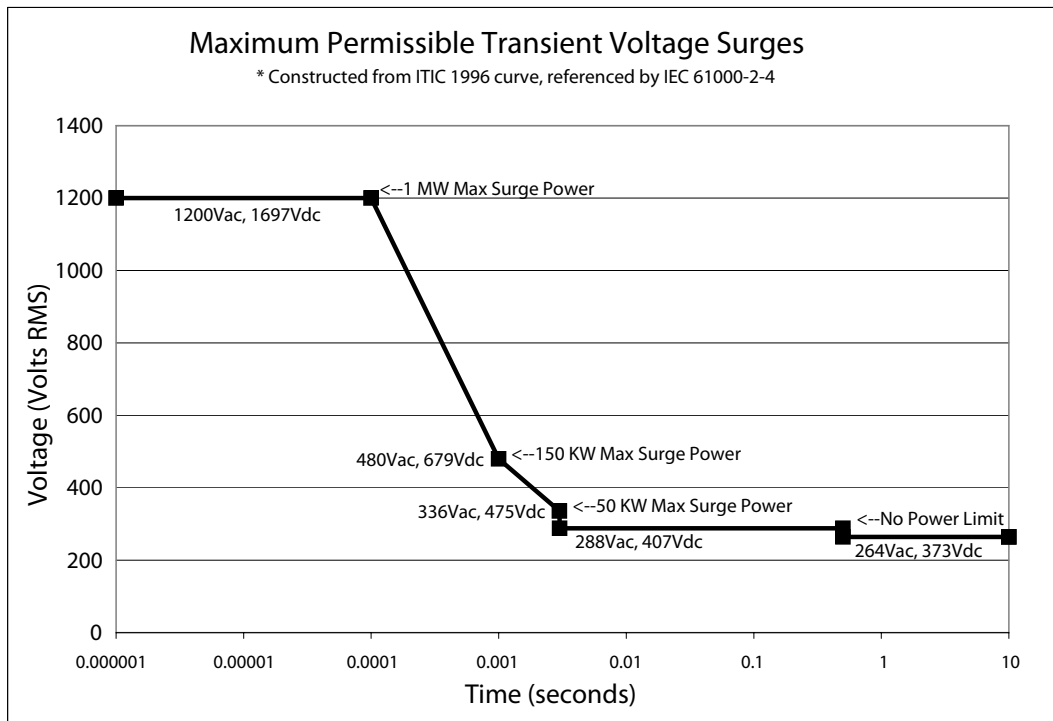

FIG. 19: LED Signals

Acceptable Size and Duration of Power Line Voltage Fluctuations

The Motor Control Module is designed to withstand voltage fluctuations from the incoming power supply. If the incoming power supply goes outside of the tolerable range, an over-voltage condition is flagged and the system shuts down in an alarm state. Excessive or repeated over-voltage may permanently damage hardware. The chart below shows the permissible magnitude and duration of temporary over-voltage events. Consult a qualified electrician if there are any concerns about the available power supply.



Fluid Control Module

Diagnostic Information

Module Status LED Signal	Diagnosis
Green on	System is powered up
Yellow	Internal communication in progress
Red solid	FCM hardware failure. Replace FCM.
Red flashing fast	Uploading software
Red flashing slow	Token error. Remove token and upload software token again.

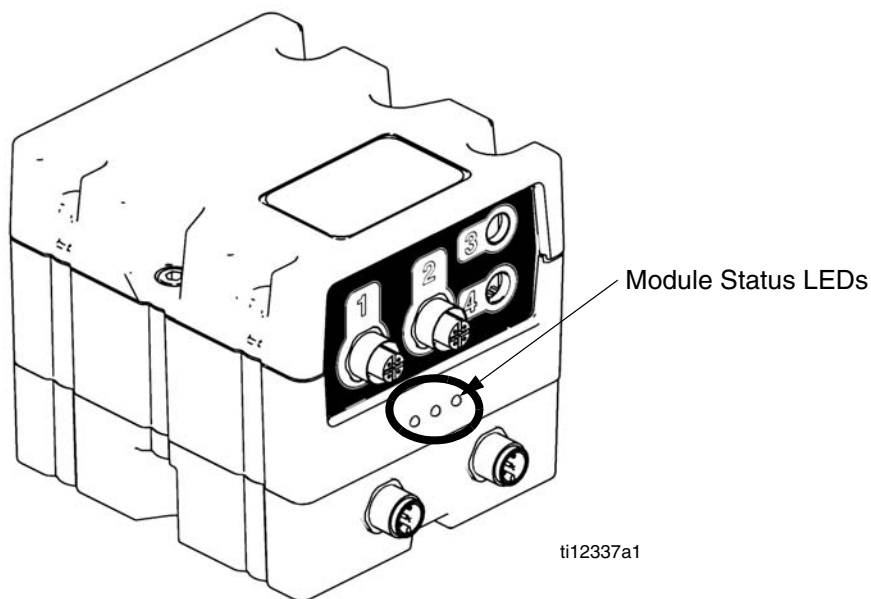

FIG. 20:

Temperature Control Module

Diagnostic Information

Module Status LEDs

Signal	Description
Green on	Temperature control module is powered up.
Yellow on	Internal communication in progress.
Red solid	Temperature control module failure. See Troubleshooting table.
Red flashing	Software is updating.
Blue light off (High Power Module only)	Temperature control module is off. See Troubleshooting table.
Blue flashing (High Power Module only)	Length of flashes indicates amount of power running through temperature control module.

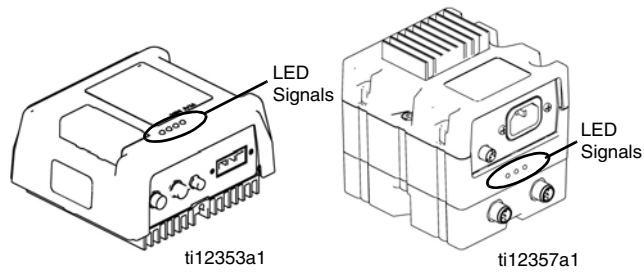

































FIG. 21: LED Signals

















Appendix A - ADM Icons Overview







Setup Screen Icons

Icon	Description
	Enter Screen
	Exit Screen
	<i>On Learn Mode Calibration screen:</i> Move pump <i>All other screens:</i> Begin Dispense
	Stop Dispense
	Abort Changing the Label
	Select left direction
	Select right direction
	Backspace
	Back to main calibration screen from learn mode calibration screen or Back to system screen 2 from mix head operating details screen
	Access Learn Mode Calibration screen
	Run MCM Learn Mode
	Proceed to next step in calibration procedure
	<i>On Main Calibration screen:</i> Calibrate Weight Dispense or Enter Specific Gravity Information <i>On Flow Meter Calibration screen:</i> Use Dispensed Material Weight to Calibrate Flow Meters. If pressed, icon will change and units are changed to volume units.
	Erase Selected Item or Control Data

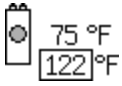
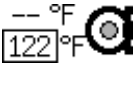
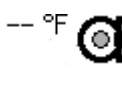

Icon	Description
	Erase All Counters on Page
	Access Flowmeter Calibration
	Valve Details
	Selects all shots to be changed to the same user specific value
	Pressure
	Shot Number
	Sequence Position
	Flow
	Time (Duration)
	Tank Blanket Heater
	Primary Heater
	Heated Hose
	Chiller
	Move Cursor to the Left
	Move Cursor to the Right
	Upper/Lower Case Letters
	Positive / Negative

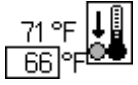
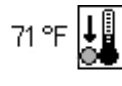
Run Screen Icons

Icon	Description
	Select mode.
	Set system in park (icon will be selected when system is parked)
	Open, Close Valve
	A (Red) and B (Blue) refill button (Press to start/abort refill)
	With a mix head installed: Turns on the mix head hydraulics and puts the machine in low pressure circulation. Press a second time to turn off instigated system action.
	<i>If Green:</i> Allowed to Dispense <i>If Red:</i> Not Allowed to Dispense
	Stop Dispense
	Jump in and use the key pad to select a shot number.
	Skip the next shot in selected sequence. Only available when the system is not dispensing.
	Abort sequence and reset to first valid position
	Edit Operator Dispense Setting
	Press to enter the Conditioning Control screen
	Turn on or off the highlighted zone.
	Turn on or off all zones.
	Erase a single batch
	Erase all batch data points

Icon	Description
	Sets machine to low pressure
	Sets machine to high pressure
	Current and setpoint temperature for primary heater. Not displayed if heat zone is not enabled.
	Current and setpoint temperatures for heated hose. Not displayed if heat zone is not enabled.
	Current temperatures for heated hose monitor. Not displayed if heat zone is not enabled.
	Current and setpoint temperatures for tank blanket. Not displayed if heat zone is not enabled.
	Current temperatures for tank blanket monitor. Not displayed if heat zone is not enabled.
	Current and setpoint temperatures for chiller. Not displayed if heat zone is not enabled.
	Current temperatures for chiller monitor. Not displayed if heat zone is not enabled.
	Amount of material moved through pump (volume tracking)
	Cycles

Appendix B - ADM Setup Screens Overview

The ADM will start in the Run screens at the “Home” screen. From the Run screens, press  to access the Setup screens. If the Setup screens password is turned on, use the ADM keypad to enter the password then press .

From the Setup screens, press  to access the Run screens. For Run screens information, see **Appendix C - ADM Run Screens Overview** on page 82. FIG. 22 shows the flow of the Setup screens.

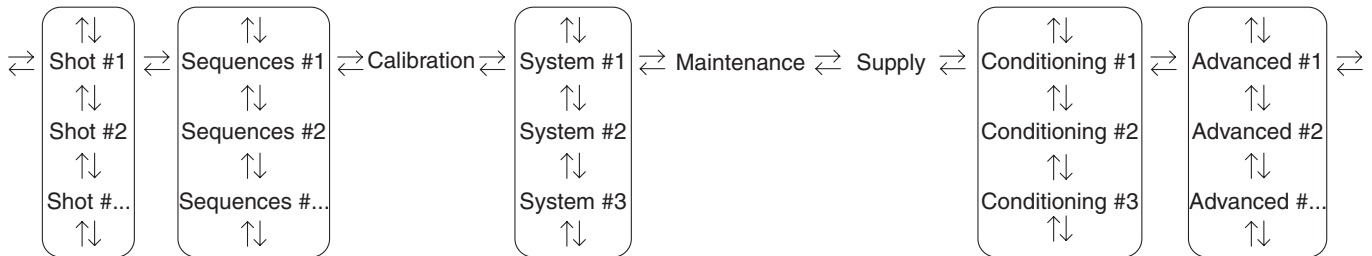
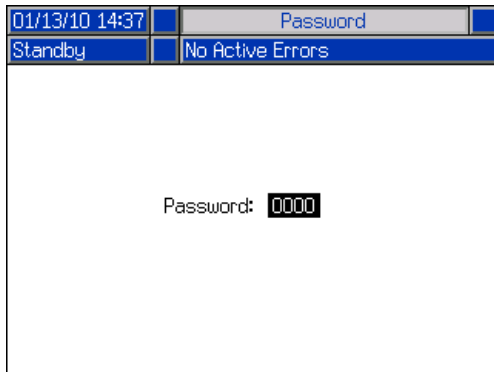



FIG. 22: Setup Screens Navigation Diagram

Shots Screen



This screen allows the user to edit shot definitions. The contents of this screen change based on the Dispense and Control Mode selections. Shots may be defined by pressure or flow rate depending upon the Control Mode selection and by time (duration), volume, or weight depending upon the Dispense Mode selection. See System Screen #1 for Control and Dispense Mode options. See **Home Screen, Shot Mode** on page 83 for information on how to use predefined shots.

NOTE: 100 shot definition are available across ten pages.

To edit a shot definition:

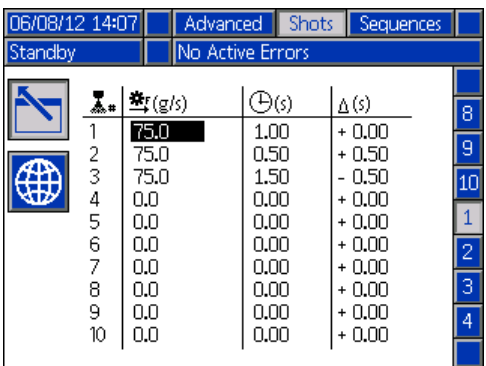
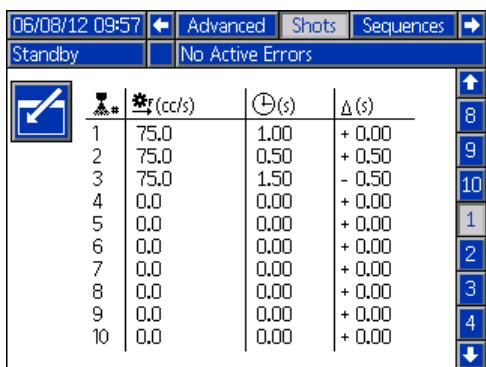
1. Press  then use the arrow keys to navigate to the desired value.



2. Type the new value then press  to accept the new value.
3. If desired, press  to quickly enter the same value for the rate and time/volume/weight.
4. Repeat step 2 as required.

Due to variation in material properties, the Δ column gives the ability to adjust the shot time/volume/weight for each defined shot.

NOTE: If the Δ column is used, it is recommended that a minimum of 5 shots are dispensed, measured and averaged for each dispense before entering a value for the Δ column.

Time Based Example:

A 75 cc/s shot is defined to dispense for 2 seconds.

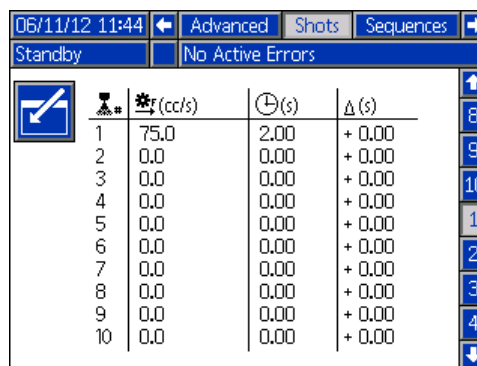

1. Dispense 5 shots into 5 separate containers.
2. Measure the dispensed amount and record the data.

Shot	Example 1 Dispensed Volume (cc)	Example 2 Dispensed Volume (cc)
1	146.2	156.2
2	146.4	156.4
3	145.6	155.6
4	145.8	155.8
5	146.0	156.0

3. Calculate the average of the 5 shots.
Example 1 = 146cc
Example 2 = 156cc

- Use the following formula to calculate the Δ column value.

$$\frac{((\text{Flow Rate} \times \text{Time}) - \text{Average Volume})}{\text{Flow Rate}}$$

Example 1:

$$\frac{((75\text{cc/sec} \times 2\text{sec}) - 146\text{cc})}{75 \text{ cc/sec}} = 0.053 \text{ sec}$$

Example 2:

$$\frac{((75\text{cc/sec} \times 2\text{sec}) - 156\text{cc})}{75 \text{ cc/sec}} = -0.08 \text{ sec}$$

- Enter the calculated value in the Δ column.

Example 1:

06/11/12 11:44		Advanced	Shots	Sequences
Standby		No Active Errors		
	⌚	⚙️(cc/s)	⌚(s)	Δ(s)
1	75.0	2.00	+0.05	
2	0.0	0.00	+0.00	
3	0.0	0.00	+0.00	
4	0.0	0.00	+0.00	
5	0.0	0.00	+0.00	
6	0.0	0.00	+0.00	
7	0.0	0.00	+0.00	
8	0.0	0.00	+0.00	
9	0.0	0.00	+0.00	
10	0.0	0.00	+0.00	

Example 2:

06/11/12 11:44		Advanced	Shots	Sequences
Standby		No Active Errors		
	⌚	⚙️(cc/s)	⌚(s)	Δ(s)
1	75.0	2.00	-0.08	
2	75.0	0.00	+0.00	
3	75.0	0.00	+0.00	
4	0.0	0.00	+0.00	
5	0.0	0.00	+0.00	
6	0.0	0.00	+0.00	
7	0.0	0.00	+0.00	
8	0.0	0.00	+0.00	
9	0.0	0.00	+0.00	
10	0.0	0.00	+0.00	

NOTE: Depending on the dispensed volume average, the Δ column may be either a positive or negative value.

Volume/Weight Based Example:

A 75 cc/s shot is defined to dispense for 75 cc.

06/12/12 13:47		Advanced	Shots	Sequences
Standby		No Active Errors		
	⌚	⚙️(cc/s)	⌚(cc)	Δ(cc)
1	75.0	75.0	+0.0	
2	0.0	0.0	+0.0	
3	0.0	0.0	+0.0	
4	0.0	0.0	+0.0	
5	0.0	0.0	+0.0	
6	0.0	0.0	+0.0	
7	0.0	0.0	+0.0	
8	0.0	0.0	+0.0	
9	0.0	0.0	+0.0	
10	0.0	0.0	+0.0	

- Dispense 5 shots into 5 separate containers.
- Measure the dispensed amount and record the data.

Shot	Example 3 Dispensed Volume (cc)
1	72.2
2	72.4
3	72.6
4	72.8
5	72.5

- Calculate the average of the 5 shots.
Example 3 = 72.5cc
- Use the following formula to calculate the Δ column value.

$$(\text{Requested Amount} - \text{Actual Amount})$$

Example 3:

$$(75\text{cc} - 72.5\text{cc} = 2.5\text{cc})$$

5. Enter the calculated value in the Δ column.

Example 3:

06/12/12 13:47				
← Advanced Shots Sequences →				
Standby No Active Errors				
		(cc/s)	(cc)	Δ (cc)
1		75.0	75.0	+ 2.5
2		0.0	0.0	+ 0.0
3		0.0	0.0	+ 0.0
4		0.0	0.0	+ 0.0
5		0.0	0.0	+ 0.0
6		0.0	0.0	+ 0.0
7		0.0	0.0	+ 0.0
8		0.0	0.0	+ 0.0
9		0.0	0.0	+ 0.0
10		0.0	0.0	+ 0.0

Sequences Screen

This screen allows the user to edit sequence information. The contents of this screen change based on the Dispense and Control Mode selections.

Dispense detail is shown as volume, time, or weight depending on which Dispense Mode is selected. See **System Screen 1** on page 73 for Dispense Mode options. See **Home Screen, Sequence Mode** on page 84 for information on how to use predefined sequences.

NOTE: Five sequences with 20 positions each are available across 10 pages.

To edit a sequence:

1. Press the Enter screen button then use the arrow keys to navigate to the desired value.
2. Type the new value then press the Enter button to accept the new value.

06/08/12 15:50			
← Shots Sequences Calibration →			
Standby No Active Errors			
			(s)
A1		0	0
A2		0	0
A3		0	0
A4		0	0
A5		0	0
A6		0	0
A7		0	0
A8		0	0
A9		0	0
A10		0	0

Calibration Screen, Main

This screen shows calibration information for the system and provides access to other calibration screens. See **Calibrate HFR** on page 48 for how to use the calibration screens to calibrate the machine.

The date next to each key represents the last time that calibration was performed.

The “Cal. Min” and “Cal. Max” values are the system recognized extreme ends of piston travel. See **Calibration Screen, Learn Mode**.

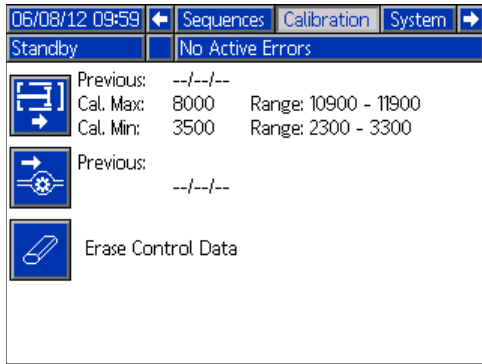

Press  to go to the **Calibration Screen, Learn Mode** screen.

Press  to erase the motor control database in the motor control module.

Calibration Screen, Learn Mode

This screen allows the user to calibrate piston position. The piston can be moved to the left and right to obtain the full range of motion. See **Calibrate HFR** on page 48 for how to use this screen to calibrate the machine.

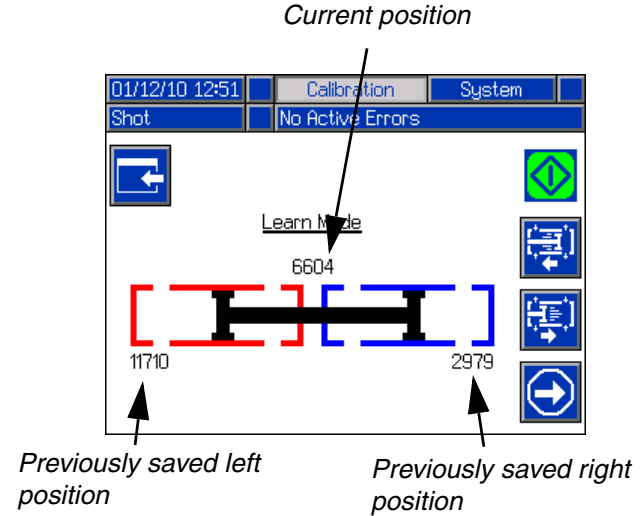

Press  and then  to move the pump all the way to the left.

Press  and then  to move the pump all the way to the right.

Press  to return to the **Calibration Screen, Main**. This saves the new left and right numbers.

System Screen 1

NOTE: Not all of the following modes may be available depending on the dispense valve selected.

This screen allows the user to set important system settings specific to what dispense applicator has been selected. Control Mode can be set to Pressure or Flow. With Control Mode set to Pressure, the machine will adjust dispense flow rate in order to maintain the requested pressure. With Control Mode set to Flow, the machine will dispense at a continuous flow rate regardless of pressure fluctuations unless pressure alarm conditions occur.

Dispense Mode can be set to Time, Volume, or Weight. Dispense Mode controls how displayed amounts are measured. If Dispense Mode is set to Weight, then the machine dispenses until the desired weight of material is dispensed. See **Calibrate HFR** on page 48 for more information.

Pump sizes and inlet pressures must be entered on this screen.

If pump sizes and inlet pressures are not entered properly, system performance will be affected. The inlet pressure must be set to the maximum feed pressure that will be seen by that side of the machine.

The maximum working pressure for the machine is displayed on this screen. The maximum working pressure is dependent on the installed hoses and dispense valve. The maximum working pressure is set to the lowest rated system component. If 2000 psi hoses are installed and the maximum working pressure displayed is not 2000 psi, see HFR repair/parts manual for instructions to set the maximum working pressure for hoses. If the installed dispense valve rating is below the maximum working pressure shown here, verify the correct dispense valve is selected on System Screen 2.

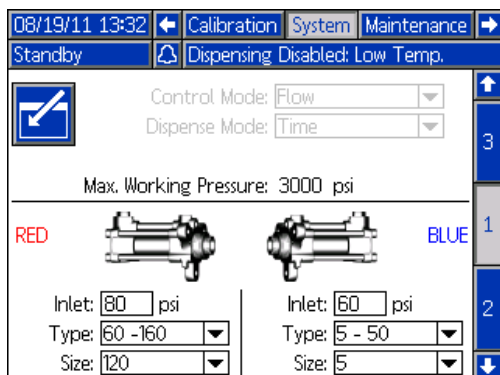

System Screen 2

This screen allows the user to set the Gel Timer properties and set which items are installed on the machine.

When enabling the Gel Timer, the user must select one of the 100 available shot definitions to use as the Gel Shot. This shot will be dispensed when the Idle Period expires. The Idle Period will begin after a dispense is completed. Any dispense operation in the middle of the timer countdown will reset the Idle Period counter. The system will generate an audible alarm based upon the user Alarm setting. The alarm will sound the user-entered number of seconds before the Idle Period expires.

The hydraulic level sensor and hydraulic RTD for both the pump line and mix head must be marked as enabled when installed in the system. If the sensors are not marked as enabled, they will be ignored by the machine controls.

Select the dispense valve installed in the system. This selection is critical to ensure proper operation of the

machine. When a mix head is selected,  button will

become active when the  is pressed. When active, pressing this button will open a screen used to define the mix head operating parameters. See the **Mix Head Operating Details Screen** on page 74.

Selecting the dispense valve will limit the system maximum working pressure to the maximum working pressure of the dispense valve. See **System Screen 1** on page 73.

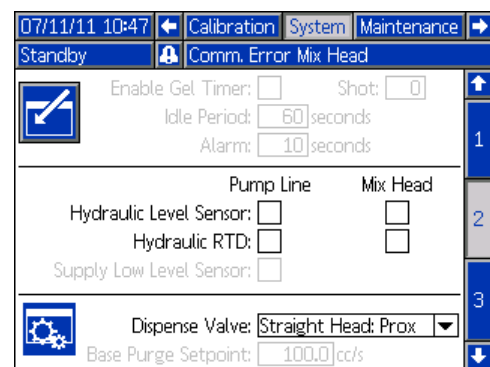

Mix Head Operating Details Screen

This screen allows the user to define the mix head operating parameters.

- **Low Pressure Circulation:** The percentage of set-point at which the system will run during low pressure circulation.
- **Pre-Dispense Circulation:** The time for which the system will circulate at high pressure prior to dispensing when the dispense command is triggered while the system is in low pressure circulation.
- **Post-Dispense Circulation:** The time duration that the system will remain in high pressure circulation after a dispense before dropping into low pressure circulation.
- **Idle Position:** Applies to an L-Head only. The position of the clean out rod when the mix head is idle.
- **Clean Out Open:** Applies to an L-Head only. The amount of time the clean out rod will remain open immediately after the completion of a dispense.
- **Clean Out Closed:** Applies to an L-Head in a Normally Open configuration only. The amount of time the clean out rod will remain closed when it closes after the completion of a dispense (after the clean out open time delay).
- **Anti-Seize Delay:** Applies to an L-Head in a Normally Closed configuration only. After a shot occurs and the cleanout piston closes, the first anti-seize delay will count down then the cleanout piston will open and close to break loose from any curing material. The second anti-seize timer will then begin counting down and the cleanout piston will open and close again to break loose from any remaining curing material. If a shot occurs before both anti-seize timers elapse, the anti-seize timers restart.

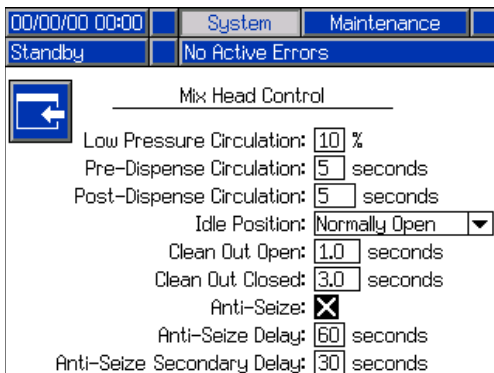





Press  to go back to the **System Screen 2**.

System Screen 3

This screen allows the user to edit the labels for the A (Red) and B (Blue) sides of the machine. The labels set for the A (Red) and B (Blue) sides of the machine are displayed throughout the screens. Labels are limited to five characters.

To edit a label:

1. Press .
2. **To edit the A (Red) label,** press . **To edit the B (Blue) label,** press the down arrow then press . The keyboard will appear on the screen. See **Keyboard Screen** on page 75.
3. Use arrow keys to select the desired letter and press  to accept the letter. To erase all text, press the Eraser softkey. To go back one letter, press the Back Arrow softkey.
4. When finished entering the new label, press the  button twice.

The pressure imbalance setting may be set from this screen. Pressure imbalance is the allowable difference in pressure between the two materials before an alarm is triggered. The input range is 250-2000 psi (2-14 MPa, 17-138 bar).

The flowmeter types are defined on this screen. The ratio deviation value is the allowable percentage before the machine displays a pop-up notification. The ratio alarm value is the allowable percentage difference before the machine will stop a dispense.

This screen allows the user to enter material specific gravities.

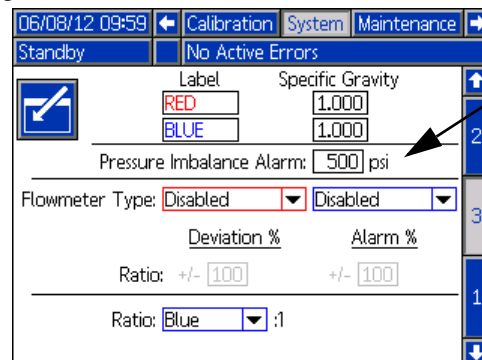





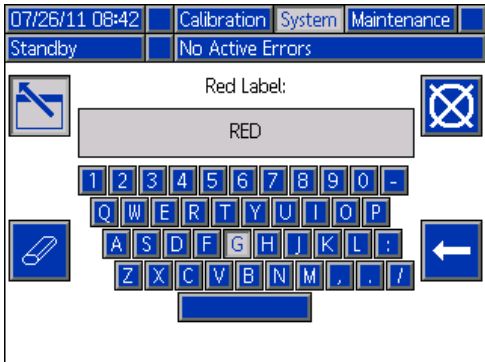

Pressure Imbalance Setting

Keyboard Screen

This screen is used to edit the A (Red) and B (Blue) labels on the ADM. Use arrow keys to select the desired

letter and press  to accept the letter.



1. Use arrow keys to select the desired letter and press  to accept the letter. To erase all text, press . To delete one letter, press . To move the cursor one letter to the left, press . To move the cursor one letter to the right, press . To toggle the letters from upper/lower case, press .

2. When finished entering the new label, press .

Flow Meter Calibration

Refer to the HFR Flow Meter Kits manual for instructions on how to calibrate the flow meters.

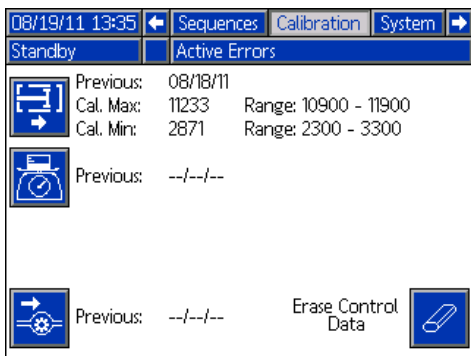



Maintenance Screen

This screen shows shot number, sequence position, and dispense valve counters. Press  and navigate to the

drop down box. Press  and scroll to a range of coun-

ters to view. Press  again to select the range of counters and display them on the screen.

Counters may be erased individually. Navigate to the counter you want to erase and press . Alternatively, each counter displayed on the page may be erased simultaneously by pressing .

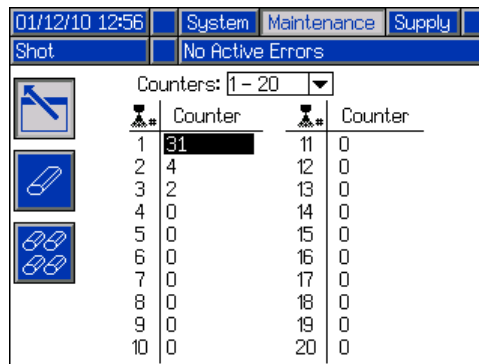

Supply Screen

This screen allows the user to specify the operating parameters for off-board, integrated tanks and indicate which positions have level sensors installed. See the Tank Feed Systems manual for information about installing level sensors, see **Related Manuals** on page 3. The user may select from the following refill settings: Disabled, Monitor, Manual, Auto Top-Off, Auto Full-Volume.

NOTE: Use the “Disabled” setting if off-board tanks are not installed.

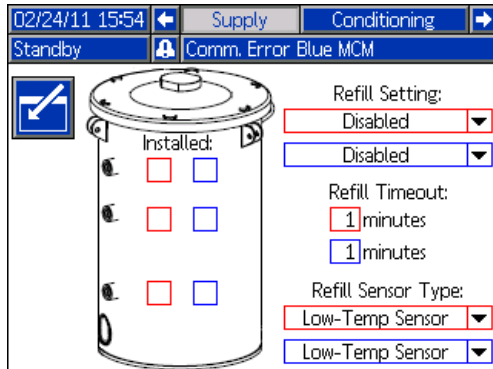

The following describes system operation when each tank mode is selected.

- **Disabled**
 - Disables tank operation
- **Monitor**
 - The top sensor generates a high level deviation and the bottom sensor generates a low level alarm
 - Refill is not supported, no button is provided on the run screens to initiate refill
 - Errors will clear when the corresponding condition clears
- **Manual**
 - The low level sensor will generate a low level alarm
 - A button is provided to the user on the run screens to instigate a manual refill operation at any time
 - Manual refill will run until either the high level sensor sees material, the user aborts the refill via the refill button on the run screens, or the refill time-out expires
 - The low level alarm will clear when the condition clears
- **Auto Top-Off**
 - The low level sensor will generate a low level alarm

- When the high level sensor does not see material, automatic refill will begin and continue until either the high level sensor sees material or until the refill time-out expires
- The low level alarm will clear when the condition clears
- A button is provided to the user on the run screens to instigate an automatic refill operation at any time, this button can also be used to abort a refill operation
- **Auto Full-Volume**
 - The low level sensor will initiate an automatic refill when it does not see material
 - Automatic refill will continue until either the high level sensor sees material or until the refill time-out expires
 - The low level alarm will clear when the condition clears
 - A button is provided to the user on the run screens to instigate an automatic refill operation at any time, this button can also be used to abort a refill operation

Refill Setting

If a refill setting other than Disabled is selected, the user must set at least two level sensor locations as installed by checking the check box on the screen. If all three locations are set to installed, the system will default to the Auto-Top Off refill setting and operate as follows:

- The low level sensor will generate a low level alarm.
- The high level sensor will generate a high level deviation and abort any automatic refill operation.
- When the middle sensor is not satisfied, automatic refill will begin and will run until either the middle sensor is satisfied, the high level sensor generates a deviation (if the middle sensor fails), or the refill time-out expires.
- The low level alarm and the high level deviation will clear when the condition clears.
- A button is provided to the user on the Run screens to instigate an automatic refill operation at any time. This button can also be used to abort a refill operation.

Refill Timeout

The refill time-out setting may be set by the user as a means to abort the refill in the case of a high level sensor failure. When an automatic refill begins, the time-out counter will begin to count down. If the timer expires before the high level sensor is satisfied, the refill will abort.

Refill Sensor Type

The Low-Temp Sensor setting limits tank temperatures to 150°F (66°C). And the High-Temp Sensor setting limits tank temperatures to 190°F (88°C).

NOTICE
If you are using low temperature sensors and select the High-Temp Sensor setting and set the temperature above 150°F (66°C), damage to the level sensors will occur.

Conditioning Screen 1

This screen allows the user to select which temperature conditioning components are installed in the system.

Check the box next to the component type for the appropriate side of the system to indicate that a component is installed. A maximum of four components may be selected. A maximum of four components and two monitoring zones may be selected.

07/11/11 09:51		Supply	Conditioning	Advanced
Shot	Red Pressure Sensor Fault			
<input checked="" type="checkbox"/>	Monitor	RED	BLUE	Monitor
<input type="checkbox"/>	<input type="checkbox"/>	<input type="checkbox"/>	<input type="checkbox"/>	<input type="checkbox"/>
<input type="checkbox"/>	<input type="checkbox"/>	<input type="checkbox"/>	<input checked="" type="checkbox"/>	<input type="checkbox"/>
<input type="checkbox"/>	<input type="checkbox"/>	<input checked="" type="checkbox"/>	<input type="checkbox"/>	<input type="checkbox"/>
<input type="checkbox"/>	<input type="checkbox"/>	<input checked="" type="checkbox"/>	<input type="checkbox"/>	<input checked="" type="checkbox"/>

Conditioning Screen 2

This screen shows the fluid path for the temperature conditioning components and temperature setpoints for each component.

NOTE: If tank blanket heaters or inline heaters are installed along with hose heat, the hose heat setting will be limited to at or below the inline or tank heat setting.

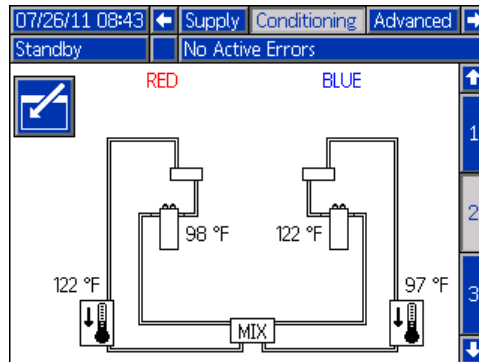

NOTE: All components are shown installed for reference only. Only 4 components can be installed at one time.

To edit the temperature setpoint and alarms for a particular component:

1. Press then use the arrow keys to navigate to the component you wish to edit.

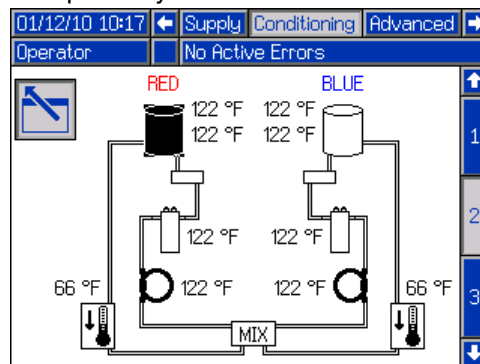

- Press  to display the setpoint and alarm values associated with that component.

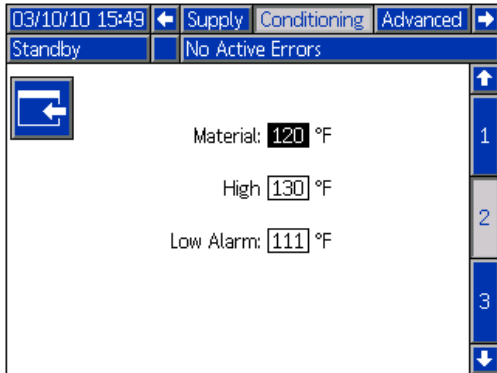

- Edit the setpoint and alarm values and then press  to return to **Conditioning Screen 2**.

NOTE: The high alarm and low alarm values must be at least +/-9°F (5°C) than the material temperature value.

Conditioning Screen 3

This screen allows the user to configure Night Mode operation. In Night Mode, the system will cycle on and off periodically or turn on at a preset time. Press  and select periodic or time schemes.

When the system is in Night Mode and in an “On” cycle, the system will circulate in low pressure. The installed conditioning zones will be on and controlling to their respective setpoints. When the system is in Night Mode and in an “Off” cycle, the system will be idle. The system will not be circulating, and the conditioning zones will not be actively controlling temperature. When in Night Mode, supply tanks will not fill.

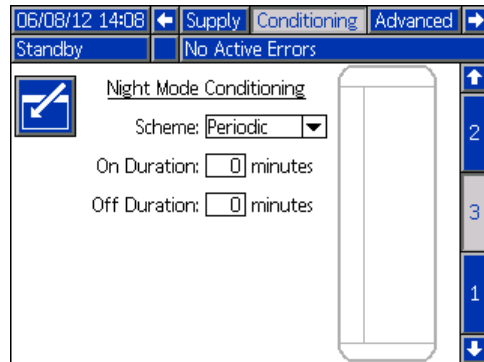

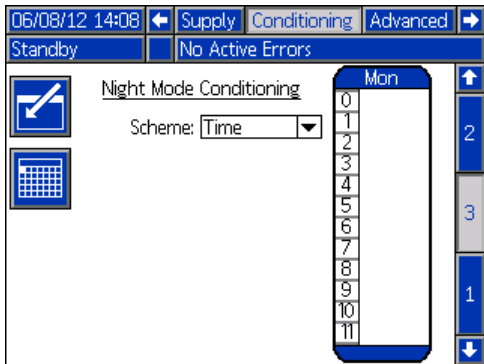

Time Based Night Mode Conditioning Screen

This screen allows the user to set a specific time each day to turn the machine on or off. The times can be set on or off by either each day separately, Monday through Friday where each day has the same on or off times, or Sunday through Saturday where each day has the same on or off times. The days can be selected by pressing the left or right arrow keys once entered into the screen.



To set the on/off machine times:

1. Press  to enter the screen
2. Press left or right arrow keys to highlight the day selection column. Continue to press the left or right arrow keys to select the desired day, work week (Monday thru Friday), or full week (Sunday thru Saturday) duration.
3. Press the up or down arrow keys to select the desired hour to schedule the on or off machine times.
4. Press  to enter the selected hour and select the desired time (15 minute increments) for either machine on or off to occur.
5. Press  and select either on or off for the time duration selected.

Bar Color	Description
Green	Machine is ON
Red	Machine is OFF

6. To erase times, repeat steps 1 thru 3 and press  once the desired time duration has been selected.

NOTE: If times are entered in the weekly schedule, individual days can not be erased.

Cold Start Up Mode

Allows the user to select what mode the machine will enter once the cold start-up is complete. Selecting no change will leave the machine in either standby or night modes circulating at the set low pressure percentage.

Auto High Pressure

Changes the machine to high pressure circulation when the mode is changed from either standby or night modes.

Calendar Time Based Night Mode Conditioning Screen

This screen shows a summary of Time Based Night Mode on or off times that were set by the **Time Based Night Mode Conditioning Screen**.

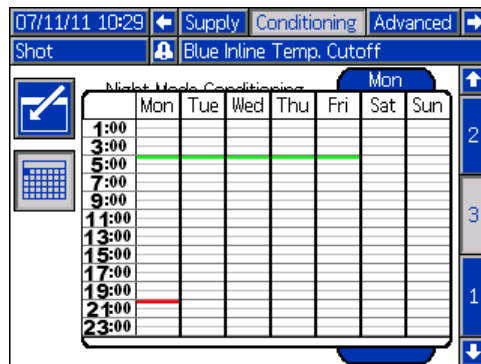

Advanced Screen 1

This screen allows the user to set the language, date format, current date, time, setup screens password, screen saver delay, and turn on or off silent mode.

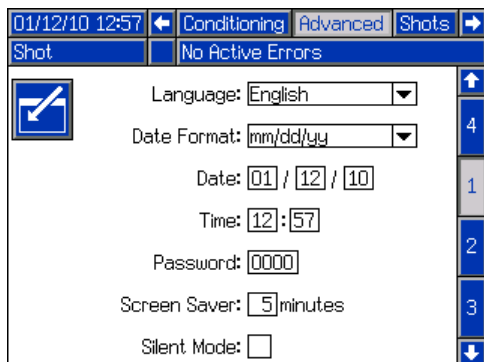

- **Language:** Available languages are English, Spanish, French, German, Chinese, Japanese, Korean, Russian, and Italian.
- **Time:** formatted in 24 hour time.
- **Password:** Enables the setup screens to be password protected. Entering “0000” disables the feature.
- **Screen Saver:** Enter the amount of time until the backlight turns off. Entering “0” leave it constantly on.
- **Silent Mode:** Check this box to turn off the buzzer for key presses.

Advanced Screen 2

This screen allows the user to set the units of measure.

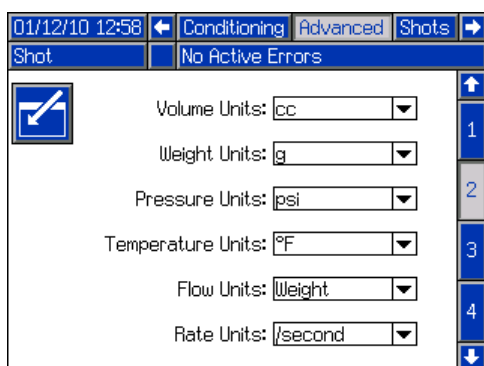

Advanced Screen 3

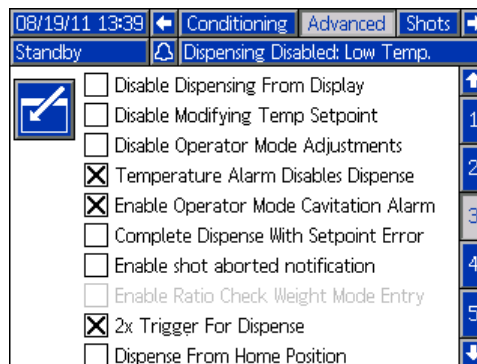

This screen allows the user to control the availability of some key system features.

- **Disable Dispensing From Display:** Check this box to disable dispensing from the ADM. A footswitch, dispense valve trigger, or other external signal will be the only way to initiate a dispense.
- **Disable Modifying Temp Setpoint:** Check this box to disable modifying temperature setpoints from the Run screens. This is only applicable if temperature control items are installed and enabled.
- **Disable Operator Mode Adjustments:** When this box is checked, the user will not be able to adjust the dispense settings in Operator Mode.
- **Low Heater Temp Disables Dispense:** When this box is checked, the system will reject dispense requests when any enabled heat zones are below their setpoint.
- **High Chiller Temp Disables Dispense:** When this box is checked, the system will disable dispensing when any enabled chiller zones are above their setpoint.
- **Operator Mode Cavitation Alarm:** Check this box to enable cavitation alarms in Operator Mode. Clear this box to disable cavitation alarms in Operator Mode.
- **Complete Dispense with Setpoint Error:** When this box is checked, the shot will continue dispensing even if the system never reaches the desired setpoint.
- **Enable Shot Aborted Notification:** When this box is checked, a pop-up notification will be displayed when a shot is aborted.
- **Enable Ratio Check Weight Mode Entry:** This option is for machines without flow meters. When this box is checked, after any ratio check shot a popup window will appear asking the user to enter the dispensed weights. Press the Cancel button to abort the entry or press the Enter button to record the new values.

Advanced Screen 4

06/08/12 09:57 ← Conditioning Advanced Shots →

Standby No Active Errors

Enable Diagnostic Screen

Low Material Disables Dispense

Enable Downloading of USB Logs

Enable USB Errors:

Date of Last Download: 06/08/12

- **Enable Diagnostic Screen:** Check this box to enable the optional ADM screens, enabling USB log downloading, and erasing USB logs. For more information about USB operation, see **Appendix F - USB Operation** on page 102. For more information about the optional screens, see **Diagnostic** screen on page 87.
- **Low Material Disables Dispense:** When this box is checked, the current dispense will terminate and prevent additional dispenses when the supply system indicates a low level.

Advanced Screen 5

08/19/11 13:40 ← Conditioning Advanced Shots →

Standby Dispensing Disabled: Low Temp.

Module	Software Part Number	Software Version
Advanced Display	16E122	1.08.069
USB Configuration	16G102	1.05.011
MCM Application Blue	15Y820	1.09.016
MCM Component Blue	16C014	1.03.001
Red Primary Heat	15M871	1.05.008
Blue Primary Heat	15M871	1.05.008
Red Hose Heat	15M871	1.05.008
Red Chiller	15M871	1.05.006
Mix Head Power Pack	16A039	1.05.057
Red Tank Monitor	16A206	1.01.001
Blue Tank Monitor	16A206	1.01.001

Numbers shown are for reference only and may be different on your system.

This screen displays software information.

Appendix C - ADM Run Screens Overview

Run screens are divided into five major sections: status, errors, events, and maintenance. The following diagram demonstrates the flow of the Run screens beginning with the Home screen.

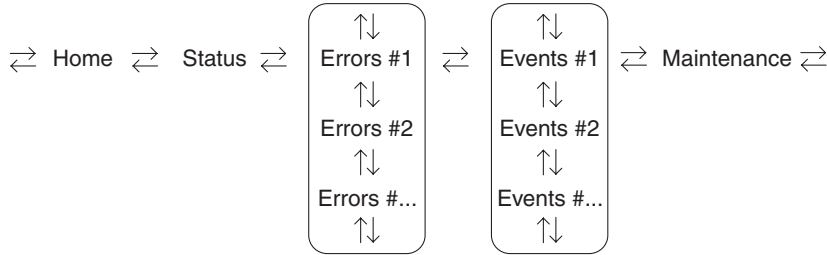





FIG. 23: Run Screens Navigation Diagram

Home Screen

The Home screen is the first screen that displays in the Run screens. It shows the current fluid pressure on the A (Red) and B (Blue) fluid outlets of the pump and if there are any active errors. If tanks are installed in the system, the fill level is shown on each tank. The ratio is also displayed as either Red:1 or Blue:1 depending on which display has been setup.

To select an operating mode, press the Select Mode button  repeatedly until the desired mode is shown then press the Enter button  to select the mode. Alternately, press the Select Mode button and use the up and down arrow keys until the desired mode is shown, then press the Enter button  to select the mode. The available operating modes are operator, sequence, shot, standby, night, and disabled.

Home Screen, Disabled Mode

When this mode is selected, the machine will not be able to dispense or condition (heat/cool) material. The setup screens cannot be accessed while in Disabled mode. Use the Select mode button to exit Disabled mode.

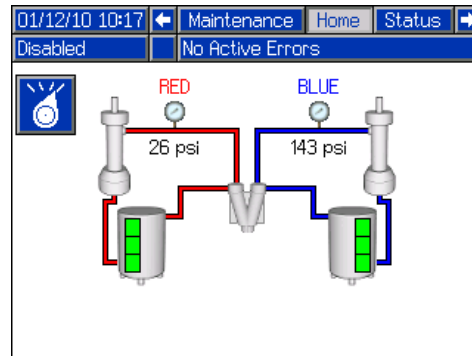



* Supply tanks shown for reference only. Your system may not include supply tanks.

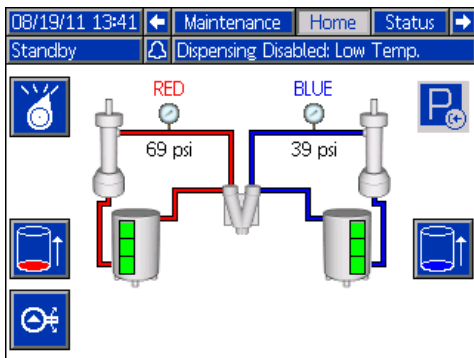

Home Screen, Standby Mode

In Standby Mode, the user can enable heating, park the pumps, refill the tanks, circulate materials.



Press  to change operating modes.

Press  to move the pumps all the way to the left and turns the hydraulic power pack off.



Press  or  to initiate a tank refill. If a tank is filling, pressing either button will abort the filling operation.

Press  to stop or start the hydraulic power pack and run the start-up process.

Home Screen, Shot Mode

This mode allows the user to select one of 100 pre-defined shot numbers. See **Shots Screen** on page 69 for information about editing shot definitions.

To use a predefined shot:

1. Enter shot mode.
2. Press  and use the numeric keypad to enter the desired shot number.
3. Press  to select the shot number.
4. Press  to initiate a dispense. The system will go to high pressure mode and dispense a shot after the pre-dispense timer, see **Mix Head Operating Details Screen** on page 74, expires.

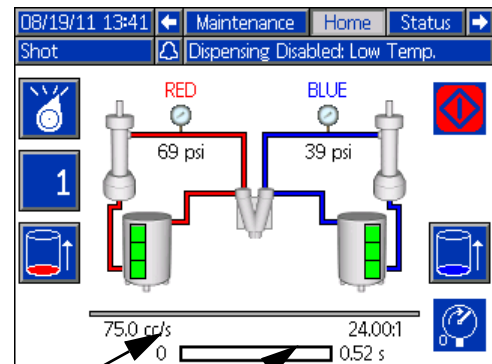

NOTE: There is a three second delay after a dispense before another dispense can be initiated



Target Flow

Ratio

Target recipe time

5. Press  to switch between low and high pressure modes without dispensing.
6. During a dispense, press  to abort the dispense.
7. See **Home Screen, Standby Mode** on page 83 for other button functions.



Home Screen, Sequence Mode

This mode allows the user to select one of five sequences (A-E). The progress bar on the bottom of the screen shows the progress of a shot dispensing from the selected sequence. See **Sequences Screen** on page 71 for information about editing sequence definitions.

To use a predefined sequence:

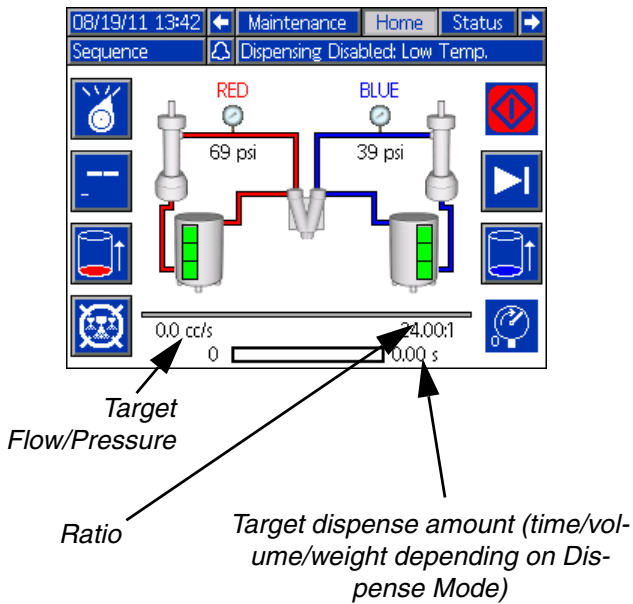

1. Enter Sequence Mode.
2. Press the sequence letter/position selection button.
3. Use the left and right arrows to toggle between letter and position selection. When selecting a sequence letter (A-E), use the up and down arrow keys to scroll through the available letters. When selecting a sequence position, type in the desired position with the numeric keypad. The system will reject invalid letter/position selections.
4. Press  to accept the sequence letter/position.
5. Press the Dispense button to begin dispensing.





6. Press  to skip to the next sequence position.
7. Press  to abort the sequence.
8. See **Home Screen, Shot Mode** on page 83 for other button functions.

Home Screen, Operator Mode

This mode allows users to set a pressure or flow rate to dispense material without using predefined shot information. Pressure or flow rate availability is dependent on the Control Mode selection, see **System Screen 2** on page 73.

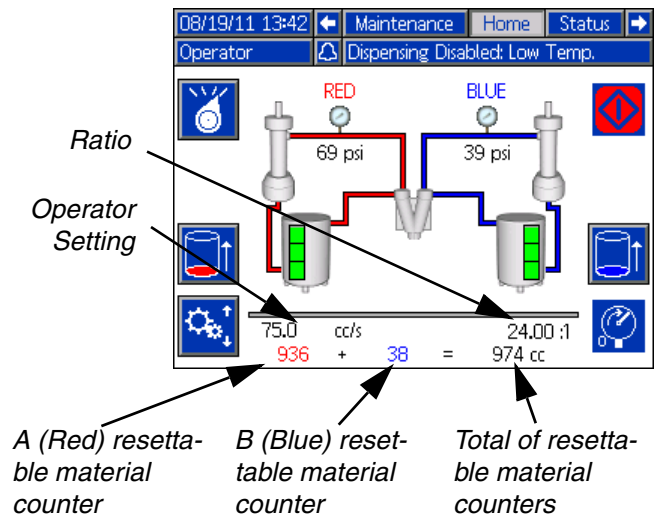
1. To edit the flow rate, press . The value to change will now be highlighted. Type the new value then press  to accept it.



2. Press  to initiate a dispense. The system will go to high pressure mode and dispense a shot after the pre-dispense timer, see **Mix Head Operating**

Details Screen on page 74, expires. Press the  to stop the dispense.

NOTE: There is a three second delay after a dispense before another dispense can be initiated.

3. If an external trigger is used, press and hold the trigger to initiate a dispense. Release the trigger to stop the dispense.
4. See **Home Screen, Shot Mode** on page 83 for other button functions.

Home Screen, Night Mode

In Night Mode, the system will cycle on and off periodically. The recirculation on/off cycle begins automatically upon entering Night Mode. See **Conditioning Screen 3** on page 78.

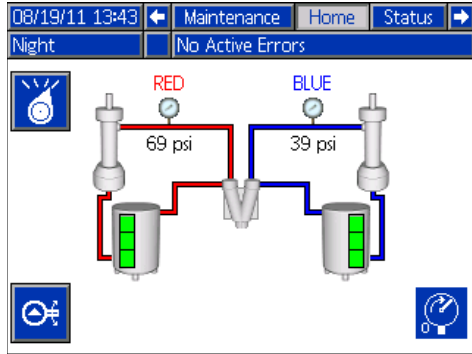

Home Screen, Disabled Mode

When this mode is selected, the machine will not be able to dispense or condition (heat/cool) material. The setup screens cannot be accessed while in Disabled mode. Use the Select mode button to exit Disabled mode.

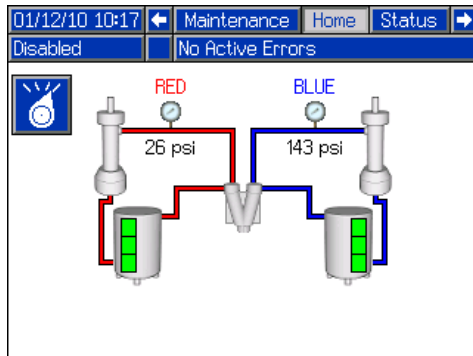

Status Screen

The status screen provides all of the operational functionality of the Home screen except for operating mode selection. Refer to the Home screen and operating mode descriptions for information on this functionality.

In addition to the functionality provided by the Home screen, the Status screen also provides material conditioning information and control.

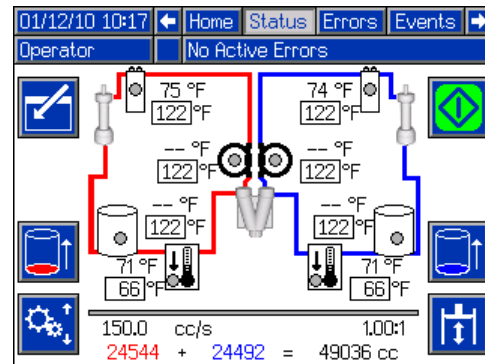



- ◆ No setpoint box will be displayed if selected as monitor zone.

Status Screen, Conditioning Control



This screen allows users to turn on and off heat zones individually or all at once. When a zone is on it is actively controlling temperature. Refer to the table below for color code definitions.

Zone Setting	Color	Definition
OFF	Black	Dispense Disabled
	Grey	Dispense Allowed
ON	Yellow	Dispense Disabled
	Green	Dispense Allowed

To turn a single zone on/off:

1. Press  to enter the Conditioning Control screen.
2. Use the arrows keys to navigate to the desired zone.
3. Press  to turn the selected zone on. When a zone is on, the button will be selected. Press the button again to turn the zone off.

To turn all zones on/off:

1. Press  to enter the Conditioning Control screen.
2. Press the  to turn on all zones. When one or more zones are on, the button will be selected. Press the button again to turn all zones off.

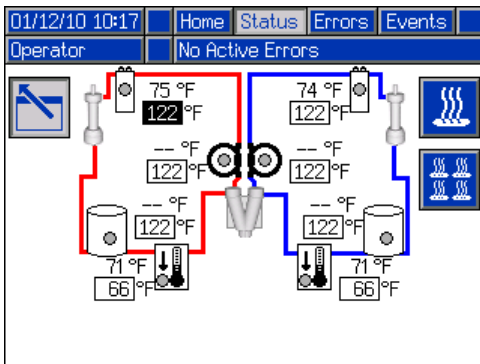

All zones shown for reference. Only four zones may be active at one time.

- ◆ No setpoint box will be displayed if selected as monitor zone.

Errors Screens

This screen shows users a list of errors that have occurred in the system. Each error entry includes a description and error code along with a date and time stamp. There are 5 pages, each holding 10 errors. The 50 most recent errors are shown.

Refer to the **Troubleshooting** section on page 58 for a detailed description of all of the system errors.

03/10/10 15:34		Status	Errors	Events
Shot	No Active Errors			
Date	Time	Code-Class	Description	
03/09/10	16:35	L122-D:	Blue Low Material Level	↑
03/09/10	15:05	CAC3-A:	Comm. Error Red Tank	3
03/09/10	15:05	P6B2-D:	Blue Pressure Sensor Fault	4
03/09/10	15:05	P6A1-D:	Red Pressure Sensor Fault	5
03/09/10	15:05	D6A1-D:	Position Sensor Fault	
03/09/10	15:05	T4H1-A:	Oil Temp. Shutdown	1
03/09/10	15:05	T4N1-A:	Motor Temp. Shutdown	
03/09/10	13:48	L122-D:	Blue Low Material Level	2
03/09/10	13:47	L122-D:	Blue Low Material Level	
03/09/10	13:44	L122-D:	Blue Low Material Level	↓

Events Screens

This screen shows users a list of events that have occurred in the system. Each event includes a description and event code along with a date and time stamp. There are 20 pages, each holding 10 events. The 200 most recent events are shown.

Refer to the **Troubleshooting** section on page 58 for a detailed description of all of the system events.

03/10/10 15:32		Errors	Events	Maintenance
Shot	No Active Errors			
Date	Time	Code-Class	Description	
03/09/10	10:09	EM00-R:	System Powered Off	6
03/08/10	16:14	EQU1-R:	Settings Downloaded	7
03/08/10	16:14	EQU3-R:	Language Downloaded	8
03/08/10	16:14	EQU5-R:	Logs Downloaded	9
03/08/10	16:13	EA00-R:	Disp. Occurred (Shot 2)	10
03/08/10	16:13	EA00-R:	Disp. Occurred (Shot 2)	11
03/08/10	16:13	EA00-R:	Disp. Occurred (Shot 2)	12
03/08/10	16:13	EA00-R:	Disp. Occurred (Shot 2)	
03/08/10	16:13	EA00-R:	Disp. Occurred (Shot 2)	
03/08/10	16:13	EA00-R:	Disp. Occurred (Shot 2)	

Maintenance Screen 1

This screen displays historical information for each pump in the system. The Batch counters are resettable and count both material usage and pump cycles. The Total counters are not resettable by the user. They also count both material usage and pump cycles. For material usage counters, units are displayed next to the volume/weight indicator icons.

To erase a batch counter, press the Enter Screen button and navigate to the field to be erased. Press the Erase Single button to erase that data point. Alternatively, the Erase All button may be pressed to erase all of the batch data points simultaneously.

01/12/10 12:41	Events	Maintenance	Home																					
Sequence	No Active Errors																							
	<table border="1"> <tr> <td></td> <td>RED</td> <td>BLUE</td> </tr> <tr> <td colspan="3">Batch</td> </tr> <tr> <td></td> <td>475406</td> <td>519589</td> </tr> <tr> <td></td> <td>23737</td> <td>23737</td> </tr> <tr> <td colspan="3">Total</td> </tr> <tr> <td></td> <td>241650175</td> <td>270756665</td> </tr> <tr> <td></td> <td>26959</td> <td>26959</td> </tr> </table>				RED	BLUE	Batch				475406	519589		23737	23737	Total				241650175	270756665		26959	26959
	RED	BLUE																						
Batch																								
	475406	519589																						
	23737	23737																						
Total																								
	241650175	270756665																						
	26959	26959																						

NOTE: In a circulation system, the pipeline must be stopped to erase counters.

Optional Screens

The optional Diagnostic screen can be enabled in the **Advanced Screen 4** screen, see page 81.

Diagnostic

07/26/11 08:28	Maintenance	Diagnostic	Home
Standby	No Active Errors		
Temperature(°F)			
IGBT	Capacitor	Motor	Hydraulic
79	97	73	--
Current (Amps)			
BUS	Phase 1	Phase 2	Phase 3
0.0	0.0	0.0	0.0
Voltage (Volts)		Speed (RPM)	PWM
BUS	Motor	Motor	Motor
335	0	0	0

The Diagnostic screen shows status information for various system components.

Appendix D - ADM Error Codes

Error Code	Error Name	Error Description	Error Type	Cause	Solution
A4H3	Mix Head Motor Overload			Refer to AC Power Pack manual	
DEH3	Soft Stop Asserted				
MBH3	Low Mix Head Oil Level				
P1H3	Low Accumulator Pressure				
P4H3	High Accumulator Pressure				
T4H3	High Mix Head Oil Temp.				
WDF3	M1 Material Rod Shift Fail				
WDD3	M1 Cleanout Rod Shift Fail				
0500	Invalid Weight Cal. Data	The three point calibration data is invalid, system will operate in weight mode but will attempt to volumetrically calculate weight. This will lead to consistent shots which will be offset for the desired dispense amount.	Deviation	Invalid data	Re-calibrate the machine
02D0	Low Flow Advisory	Pump velocity is too low.	Advisory	Pump flow setpoint is lower than one eighth of the total pump volumes	Increase the pump flow setpoint
A4A6	Red Blanket Overcurrent	An over current was detected on the output	Alarm	Bad heaters	Measure resistance of heater
A4B5	Blue Blanket Overcurrent				
A4A3	Red Inline Overcurrent				
A4B1	Blue Inline Overcurrent				
A4A2	Red Hose Overcurrent				
A4B4	Blue Hose Overcurrent				
A4A7	Red Chiller Overcurrent			High voltage	Measure voltage across the disconnect switch. Voltage should measure between 190 and 264 Vac.
A4B8	Blue Chiller Overcurrent			Shorted Temperature Control Module	If temperature rises for a zone that has been disabled, replace Temperature Control Module
A4H1	Motor Over Current	High current has been detected on a phase and has been shutdown to prevent damage	Alarm	Bad internal wiring of the motor Short circuit of motor wiring	Replace motor Check wiring to the motor to ensure no bare wires are touching and that no wires are shorted to ground
A4M1	Motor Over Current	Too much current is being drawn from the wall	Alarm	Low voltage from the wall during load	Make sure the supply line is properly sized for the load and is above the minimum voltage requirements

Error Code	Error Name	Error Description	Error Type	Cause	Solution		
A4N1	Motor Over Current	A hardware current fault has occurred causing a system shutdown	Alarm	Short circuit of motor wiring	Check wiring to the motor to ensure no bare wires are touching and that no wires are shorted to ground		
				Motor rotor has become locked	Unplug the directional valve (so pressure will not build) and try to move the motor again. If this succeeds then the power pack may need to be replaced. If the motor is still unable to move, the bearings or hydraulic pump have likely failed in the motor and will need to be replaced.		
A7A6	Red Blanket Control Fault	Unexpected current to heater/chiller	Alarm	Shorted Temperature Control Module	If temperature rises for a zone that has been disabled, replace Temperature Control Module		
A7B5	Blue Blanket Control Fault						
A7A3	Red Inline Control Fault						
A7B1	Blue Inline Control Fault						
A7A2	Red Hose Control Fault						
A7B4	Blue Hose Control Fault						
A7A7	Red Chiller Control Fault						
A7B8	Blue Chiller Control Fault						
A8A6	No Red Blanket Current	No current to the conditioning zone	Alarm	Tripped circuit breaker	Visually check circuit breaker for a tripped condition		
A8B5	No Blue Blanket Current						
A8A3	No Red Inline Current						
A8B1	No Blue Inline Current						
A8A2	No Red Hose Current			Low power	Measure voltage across input terminals on power line filter. Voltage should measure between 190 and 264 Vac		
A8B4	No Blue Hose Current						
A8B7	No Red Chiller Current					Cable unplugged/loose power	Check for loose or disconnected wires or plugs
A8B8	No Blue Chiller Current					Bad heater(s)	Measure resistance of heater(s)
A9C1	Motor Over Current	A software error has occurred commanding too much current	Alarm	Bad Motor Control Module code	Check for MCM software update, load latest MCM software, if problem persists contact Graco		
B9C0	Small Shot Request	The requested dispense amount is below the minimum amount of the system (25% of the combined pump volumes is the minimum)	Deviation	Pumps are defined with the wrong size	On the ADM go into the Setup screens to the System screens then make sure that the pump sizes are defined correctly		
B9C1		The requested dispense amount (time/volume/weight) is below the minimum amount of the system		Requested shot is below the capabilities of the current pump setup	If the user has to be able to take the shot the system must be fitted with smaller pumps		
				Short shot size	Increase the time/volume/weight of the shot		

Appendix D - ADM Error Codes

Error Code	Error Name	Error Description	Error Type	Cause	Solution
CAA2	Comm. Error Red Hose	Communication error	Alarm	Module missing power	Check power supply connection
CAA3	Comm. Error Red Inline			Module not programmed	Program the module
CAA6	Comm. Error Red Blanket			Module bad	Replace module
CAA7	Comm. Error Red Chiller				
CAB1	Comm. Error Blue Inline				
CAB4	Comm. Error Blue Hose				
CAB5	Comm. Error Blue Blanket				
CAB8	Comm. Error Blue Chiller				
CAC1	Comm. Error Motor				
CAC2	Comm. Error MCM				
CAC3	Comm. Error Red Tank				
CAC4	Comm. Error Blue Tank				
CAC5	Comm. Error Mix Head				
CAC6	Comm. Error Mix Head 2				
CAC7	Comm. Error Ratio Monitor				
CACN	Comm. Error Gateway				
CACP	Comm. Error DGM				
CACR	Comm. Error Remote Pendant				
CUCN	Gateway Heartbeat Error	Heartbeat Error	Alarm	PLC is not maintaining heartbeat	Ensure PLC is triggering the heartbeat
				Module missing power	Check power supply connection
				Module not programmed	Program the module
				Module Bad	Repalce module
D1A1	Setpoint Not Reached	The set point was not reached and the pump was shutdown	Deviation	Material restriction too high for requested flow	Reduce flow request
D4A1	Setpoint Exceeded	The maximum cycles per minute of the pump has been exceeded	Deviation	Restriction for the pump is not sufficient	Increase the restriction or lower the set point
D2A1	Setpoint Not Reached	The set point was not reached	Deviation	Pump cannot reach the requested pressure	Increase restriction in the system
				Pump cannot reach the requested flow	Decrease restriction in the system
D3A1	Setpoint Exceeded	The set point was exceeded	Deviation	System underwent a change that caused a large drop in restriction (such as new orifices)	Erase learned System Data, found in the setup screens under calibration
				No material in pumps	Make sure the material lines are open and have proper feed pressure

Error Code	Error Name	Error Description	Error Type	Cause	Solution	
D5A1	Invalid Learn Mode Data	This calibration lets the MCM know where the ends of the pump are. If the data gathered during this process is outside of normal parameters the machine will operate with a greatly reduced stroke.	Deviation	Recalibrate the machine	Run the learn mode calibration	
				Loose/bad connection	Check to ensure the pressure transducer is properly installed and all wires are properly connected	
				Bad linear position sensor	Verify pump moves to limits, if problem persists replace linear position sensor	
D6A1	Position Sensor Fault	The linear position sensor is returning data that should not be possible during normal operation	Alarm	Loose/bad connection to linear position sensor	Check to ensure the linear position sensor is properly installed and all wires are properly connected	
				Bad linear position sensor	Replace linear position sensor	
				Linear position sensor may be loose where attached to pump housing	Re-tighten the sensor and re-calibrate the machine	
DDA1	Red Pump Cavitation	Cavitation was detected on the given pump	Deviation	Insufficient material being supplied or insufficient material pressure on feed system	Verify that incoming ball valves are open	
DDB2	Blue Pump Cavitation			Debris or packout in the incoming fluid filter	Verify that feed pumps are supplying material	
					Inspect filter for debris of filler packout and clean or replace as necessary	
DFA1	Pump Not Parked	The pump failed to reach the park position	Deviation	Orifices blocked	Clear blockage	
				Hose blocked	Clear or replace hose as necessary	
				Dispense valve failed to open	Check to make sure the dispense valve is properly configured and connected to the MCM	
DR6A	Check Flow Meter Red	Flow Meter has caused a fault	Deviation	Cogs in flow meter are not turning	Check that flow meter is matched to nominal pump output	
DR6B	Check Flow Meter Blue			Cable unplugged/loose power	check of loose or disconnected wires or plugs	
DSC0	Pumps Not Defined	The type or size of the Red or Blue material pumps have not been defined	Alarm	Properly setup the system	On the ADM go into the setup screens -> System-> then make sure that the pump type and size are set (not --)	
F1A0	Low Flow Red	Flow is below the defined low limit	Alarm	Cogs in flow meter are not turning	Check that flow meter is matched to nominal pump output	
F2A0	Red		Deviation			
F1B0	Low Flow Blue		Alarm	Cable unplugged/loose power		Check for loose or disconnected wires or plugs
F2B0	Blue		Deviation			
F4A0	High Flow Red	Flow is above the defined low limit	Alarm	Cogs in flow meter are turning rapidly	Check that flow meter is matched to nominal pump output	
F3A0	Red		Deviation			
F4B0	High Flow Blue		Alarm	Cable unplugged/loose power		Check for loose or disconnected wires or plugs
F3B0	Blue		Deviation			
F7D1	Pump Failed to Stall	When the pump tried to stall to pressure the pump traveled more than it should in normal operation (only applies to dead-headed system)	Deviation	Failure of the dispense valve	Ensure the valve has a proper air supply and seals properly. If not, service the valve as necessary.	
				Material leak	Visually inspect the machine and hoses for sign of leakage. NOTE: This error will display after 2 full piston strokes so the leak will be substantial.	
				Out of material	Fill tanks	
L111	Red Low Material Level	Low material level in tanks	Deviation	Tanks low on material	Fill tanks with material	
L122	Blue Low Material Level			Loose/broken connection	If the tanks appear to have plenty of material check to make sure the level sensor is connected to the proper port and that the cord is not damaged	
				Bad level sensor	Replace level sensor	
L311	Red High Material Level	High material level in tanks	Deviation	Defective fill valve	If the tanks appear to have plenty of material check to make sure the level sensor is connected to the proper port and that the cord is not damaged	
L322	Blue High Material Level					
L6A1	Red Auto Refill Timeout	The tank stand has been filling for a time greater than expected	Deviation	No material is actually being fed	Make sure the feed pumps are operating properly	
L6B2	Blue Auto Refill Timeout			Loose level sensor connection	Check for loose or disconnected wires or plugs	
				Bad level sensor	Replace level sensor	

Appendix D - ADM Error Codes

Error Code	Error Name	Error Description	Error Type	Cause	Solution
L8A1	Red Tank Sensor Failure	A level sensor had ceased working	Deviation	Bad level sensor	Replace level sensor
DR6B	Blue Tank Sensor Failure				
MBH1	Low Oil Level	The volume of oil in the tank is below the minimum level needed for the system to properly operate	Alarm	Low oil level	Check oil level and if low add more hydraulic fluid
				Loose/bad connection	Check to ensure the hydraulic oil level sensor is properly connected to the MCM and that the wire has not been damaged
				Bad level sensor	Replace sensor
				Leak in hydraulic driver	Inspect hydraulic driver end seals and early leak detection tubing. Replace seals as necessary and replace lost oil.
				Leak in the hydraulic reservoir, heat exchanger	Inspect the hydraulic reservoir fittings and filter for leaks. Repair or replace as necessary and replace lost oil.
MBN1	Low Motor Performance	The motor magnetism has decreased to the point where performance is greatly reduced	Advisory	Prolonged exposure to heat or high voltage	If error persists and performance can no longer satisfy the user requirements the motor will need to be replaced
MMUX	USB Logs Full	USB log has reached the maximum entries	Advisory	USB logs have not been downloaded	Download USB logs to a memory stick
					Uncheck the Enable USB errors on Advanced screen 4
N1D0	Material Dispense Below Alarm	Material dispense is below the defined limit	Alarm	Cogs in flow meter are not turning	Check that flow meter is matched to nominal pump output
N2D0	Material Dispense Below Deviation		Deviation		
N3D0	Material Dispense Above Deviation	Material dispense is above the defined limit	Deviation	Cable unplugged/loose power	check for loose or disconnected wires or plugs
N4D0	Material Dispense Above Alarm		Alarm		
N4A1	Pump Failed to Move	The MCM attempted to move the pump but no movement was detected	Deviation	Motor failure	Visually check to ensure the pump is moving, if not ensure the motor is wired properly
				Hydraulic power pack failure	If motor is moving but pump is not and pressure is not building they hydraulic power pack may need servicing
				Loose/bad connection to the linear position sensor	Check to ensure the linear position sensor is properly connected to the MCM and the wiring has not be damaged
				Failure of the linear position sensor	Replace the linear position sensor
				Motor no longer coupled to hydraulic pump	Reset coupler per specifications and retighten set screws
				Supply tube from hydraulic pump to manifold is loose or broken	Retighten or replace supply tube
				Broken motor shaft	Replace motor
				Over-pressure valve dumping to tank	Verify that no outside forces are stopping the pump from moving, then inspect over-pressure valve for damage or debris
P400	Thermal Pressure Rise	Pressure has risen to an unsafe level due to thermal expansion of materials. All conditioning zones have automatically been turned off.	Deviation	High pressure	Open the dispense valve manually or open the valves to bleed pressure

Error Code	Error Name	Error Description	Error Type	Cause	Solution
P4A1	Red Pressure Shutdown	The material pump pressure exceeded the maximum operating pressure as defined in the setup screens	Alarm	Dispense valve failed to open	Check to make sure the dispense valve is properly configured and connected to the MCM
P4B2	Blue Pressure Shutdown			Bad dispense valve	Replace dispense valve
				Restriction in the material lines	Check to ensure there is no blockage
				Invalid maximum pressure defined	Make sure the requested pressure is within the max operating pressure, which can be found on the setup screen System 1
				Orifices blocked	Clear blockage
				Hose blocked	Clear blockage or replace hose as necessary
				Dispense valve failed to open	Check to make sure the dispense valve is properly configured and connected to the MCM
P4D0	Pressure Imbalance	The pressure difference between the Red and Blue material is greater than the defined amount	Alarm	Dispense line is clogged	Ensure the material flow is equally restricted on both material lines
				Pressure imbalance is defined too low	On the ADM go into the setup screens -> System-> and ensure the pressure imbalance value is the maximum acceptable to prevent unnecessary alarms which will abort dispenses
				Orifice blocks closed off too much on one or both sides	Verify that one or both of the orifice blocks dispense when adjusted to the fully open position then adjust accordingly
				Debris in the orifice block	Relieve system pressure then remove the orifice from the orifice block and inspect for debris in the cavity
				Material fillers may have packed out in an orifice	Relieve system pressure and remove the orifice from the orifice block and inspect for pack out. Clean or replace as necessary.
				Out of material	Fill tanks with material
				Feed system defective	Replace defective item
P6A1	Red Pressure Sensor Fault	The pressure sensor is providing invalid/no pressure readings	Alarm	Loose/bad connection	Check to ensure the pressure transducer is properly installed and all wires are properly connected
P6B2	Blue Pressure Sensor Fault		Alarm	Bad sensor	Replace pressure transducer
			Alarm	No material in pump	Fill tanks
R1D0	Low Ratio Alarm	Ratio monitor has detected an out of ratio condition	Alarm	Material A to Material B is out of ratio	Check feed system
R4D0	High Ratio Alarm				
R2D0	Low Ratio Deviation		Deviation		
R3D0	High Ratio Deviation				

Appendix D - ADM Error Codes

Error Code	Error Name	Error Description	Error Type	Cause	Solution		
T1A6	Red Tank Low Fluid Temp.	Fluid temperature is below the defined low alarm limit	Alarm	Tripped circuit breaker	Visually check circuit breaker for a tripped condition		
T1B5	Blue Tank Low Fluid Temp.						
T1A3	Red Inline Low Fluid Temp.						
T1B1	Blue Inline Low Fluid Temp.						
T1A2	Red Hose Low Fluid Temp.			Low power	Measure voltage across input terminals on power line filter. Voltage should measure between 190 and 264 Vac		
T1B4	Blue Hose Low Fluid Temp.						
T1A7	Red Chiller Low Fluid Temp.					Cable unplugged/loose power	Check for loose or disconnected wires or plugs
T1B8	Blue Chiller Low Fluid Temp.					Bad heater(s)	Measure resistance of heater(s)
T20X	Dispensing Disabled Low Temp	Dispensing disabled because of temperature	Advisory	Temperature is out of alarm limits	Check temperature alarm limits		
T30X	Dispensing Disabled High Temp						

Error Code	Error Name	Error Description	Error Type	Cause	Solution
T2AA	Red Hose Low Fluid Temp.	Fluid temperature for a monitor zone is below the defined low alarm limit	Deviation	Temperature is out of alarm limits	Check temperature alarm limits
T2AE	Red Tank Low Fluid Temp.				
T2AF	Red Chiller Low Fluid Temp.				
T2BC	Blue Hose Low Fluid Temp.			Cable unplugged/loose power	Check for loose or dsconnected wires or plugs
T2BD	Blue tank Low Fluid Temp.				
T2BG	Blue Chiller Low Fluid Temp.				
T3AA	Red Hose High Fluid Temp.	Fluid temperature for a monitor zone is above the defined high alarm limit	Deviation	Cable unplugged/loose power	Check for loose or dsconnected wires or plugs
T3AE	Red Tank High Fluid Temp.				
T3AF	Red Chiller High Fluid Temp.				
T3BC	Blue Hose High Fluid Temp.			Inline heater is not turned on	Turn on inline heater
T3BD	Blue Tank High Fluid Temp.				
T3BG	Blue Chiller High Fluid Temp.				
T3H1	Oil Temp. Cutback	The hydraulic oil temperature is approaching a level where damage is possible so the Motor Control Module is limiting the output to a safe level	Deviation	No power to fan	Check cord to make sure fan has power
				Debris is fan or fan grill	Clear debris from fan/fan grill
				Low air volume from fan	Try to stop fan by lightly pressing on the center with a pencil eraser. If the fan slows down easily it will need to be replaced
T3N1	Motor Temp. Cutback	Motor temperature is approaching a level where damage is possible so the motor control module is limiting the output to a safe level	Advisory	No power to fan	Check cord to make sure fan has power
				Debris is fan or fan grill	clear debris from fan/fan grill
				Low air volume from fan	Try to stop fan by lightly pressing on the center with a pencil eraser. If the fan slows down easily it will need to be replaced
				Ambient environmental conditions are too hot	Move machine to an area below 120°F
				Motor/pump coupler may be rubbing on hydraulic pump	Reset coupler per specifications and retighten set screws

Appendix D - ADM Error Codes

Error Code	Error Name	Error Description	Error Type	Cause	Solution
T4A2	Red Hose High Fluid Temp.	Fluid temperature is above the defined high alarm limit	Alarm	Defective Temperature Control Module	Replace Power Temperature Control Module
T4A3	Red Inline High Fluid Temp.				
T4A6	Red Tank High Fluid Temp.				
T4A7	Red Chiller High Fluid Temp.				
T4B1	Blue Inline High Fluid Temp.				
T4B4	Blue Hose High Fluid Temp.				
T4B5	Blue Tank High Fluid Temp.			Defective RTD	Replace RTD
T4B8	Blue Chiller High Fluid Temp.			Loose connections	Tighten connections
T4C1	Motor Control High Temp.	The temperature the MCM has reached a level where product life will be decreased drastically and has been shutdown for protection	Alarm	No power to fan	Check cord to make sure fan has power
				Debris is fan or heatsink	Clear debris from fan or heatsink
				Low air volume from fan	Try to stop fan by lightly pressing on the center with a pencil eraser. If the fan slows down easily it will need to be replaced
				Motor may be damaged	Replace motor
				Debris is packed in the MCM's heat sink fins	Clear debris from MCM heat sink fins
T4H1	Oil Temp. Shutdown	The hydraulic oil is at a temperature where performance is impacted significantly and has resulted in a system shutdown	Alarm	No Power to Fan	Check cord to make sure fan has power
				Debris in fan or fan grill	Clear debris from fan/fan grill
				Low air volume from fan	Try to stop fan by lightly pressing on the center with a pencil eraser. If the fan slows down easily it will need to be replaced
T4N1	Motor Temp. Shutdown	Motor temperature is too high and system has been shutdown to prevent possible damage	Alarm	No power to fan	Check cord to make sure fan has power
				Debris is fan or fan grill	Clear debris from fan/fan grill
				Low air volume from fan	Try to stop fan by lightly pressing on the center with a pencil eraser. If the fan slows down easily it will need to be replaced
				Ambient environmental conditions are too hot	Move machine to an area below 120°F
T6A6	Red Tank RTD Fault	RTD 1 is giving no or invalid data	Alarm	Loose or bad connection	Check RTD wiring
T6B5	Blue Tank RTD Fault				
T6A3	Red Inline RTD Fault				
T6B1	Blue Inline RTD Fault				
T6A2	Red Hose FTS Fault				
T6B4	Blue Hose FTS Fault				
T6A7	Red Chiller RTD Fault				
T6B8	Blue Chiller RTD Fault			Bad RTD	Replace RTD

Error Code	Error Name	Error Description	Error Type	Cause	Solution
T6C6	Red Blanket RTD Fault	RTD 2 is giving no or invalid data	Alarm	Loose or bad connection	Check RTD wiring
T6C5	Blue Blanket RTD Fault				
T6C7	Red Chiller RTD Fault			Bad RTD	Replace RTD
T6C8	Blue Chiller RTD Fault				
T8A6	No Heat Red Tank	No temperature rise	Alarm	Tripped circuit breaker	Visually check circuit breaker for a tripped condition
T8B5	No Heat Blue Tank				
T8A3	No Heat Red Inline				
T8B1	No Heat Blue Inline			Low Power	Measure voltage across input terminals on power line filter. Voltage should measure between 190 and 264 Vac
T8A2	No Heat Red Hose			Cable unplugged/loose power	Check for loose or disconnected wires or plugs
T8B4	No Heat Blue Hose			Bad heater(s)	Measure resistance of heater(s)
T8A7	No Cooling Red Chiller			No temperature decline	Alarm
T8B8	No Cooling Blue Chiller	Defective cooling valve	Disconnect the valve and measure the voltage across the wires when the chiller is running to ensure 24V is being delivered to the valve. If so, the cooling valve will likely need replacing.		
		Chilled water supply off	Turn on chilled water supply		
		Loose or bad connection	Check RTD wiring		
T9A6	Red Blanket Temp. Cutoff	Heater overtemperature cutoff	Alarm	Defective RTD	Replace RTD
T9B5	Blue Blanket Temp. Cutoff				
T9A3	Red Inline Temp. Cutoff			Defective High Power Temperature Control Module	Replace High Power Temperature Control Module
T9B1	Blue Inline Temp. Cutoff			Loose connections	Tighten connections
T9C6	Red Blanket Ctrl Shutdown	PCB over temperature	Alarm	Overheated Temperature Control Module	Turn conditioning zone off. Wait a few minutes. If the condition does not clear or regenerates consistently, replace heater module
T9C5	Blue Blanket Ctrl Shutdown				
T9C3	Red Inline Ctrl Shutdown				
T9C1	Blue Inline Ctrl Shutdown				
T9C2	Red Hose Ctrl Shutdown				
T9C4	Blue Hose Ctrl Shutdown				
T9C7	Red Chiller Ctrl Shutdown				
T9C8	Blue Chiller Ctrl Shutdown				

Appendix D - ADM Error Codes

Error Code	Error Name	Error Description	Error Type	Cause	Solution
V1H1	Motor Control Undervoltage	The voltage to the MCM has dropped to a level where performance is greatly affected	Alarm	Tripped circuit breaker Supply lines providing low voltage	Visually check circuit breaker for a tripped condition Check incoming voltage to ensure it is above the minimum operating voltage
V4A6	Red Blanket Overvoltage	High line voltage	Alarm	Incoming line voltage is too high	Measure voltage across disconnect switch. Voltage should measure between 190 and 264 Vac.
V4B5	Blue Blanket Overvoltage				
V4A3	Red Inline Overvoltage				
V4B1	Blue Inline Overvoltage				
V4A2	Red Hose Overvoltage				
V4B4	Blue Hose Overvoltage				
V4A7	Red Chiller Overvoltage				
V4B8	Blue Chiller Overvoltage				
V4H0	Motor Control Overvoltage	The voltage to the MCM has reached an unsafe level and has been shutdown in an attempt to prevent damage	Alarm	Supply lines providing high voltage	Check incoming voltage to ensure it is below the maximum operating voltage
W0U0	USB Update Failed	The ADM tried to upload a system settings file but failed	Alarm	System Settings file is corrupt	Replace the system settings file with a backup or new file
				System Settings file is intended for another system	Ensure that the first line in the settings.txt file contains the text GMS™. If not replace the file with the proper system update file.
WBH1	Motor Encoder Fault	An error has been detected on the motor position sensor	Alarm	Failing sensors	If error persists the motor will need to be replaced
				Loose connection	Ensure the d-sub connector to the motor is connected and the wiring is intact
WDF1	M1 Material Rod Shift Fail	The material rod failed to move on a straight head	Alarm	Stuck material rod	Check that material rod is able to freely move
				No power to directional valve	Make sure the directional valve has power
WKH1	High Motor Speed	The motor has reached a speed that should not be reached in normal operation and was shutdown to prevent possible damage	Alarm	No power to directional valve	Make sure the directional valve has power
				Bad directional valve connection	Make sure the cord to the directional valve is connected to the correct port and the cord is not damaged
				Directional valve failure	The directional valve will need to be replaced
				Hydraulic power pack failure	The hydraulic power pack will need repair
				Defective encoder	Replace encoder
				Motor no longer coupled to hydraulic pump	Reset coupler per specifications and retighten set screws
				Supply tube from hydraulic pump to manifold is loose or broken	Retighten or replace supply tube
Broken motor shaft	Replace motor				

Error Code	Error Name	Error Description	Error Type	Cause	Solution
WM06	Red Tank Con. Fault	High current to relay 1	Alarm	Broken contactor	Replace contactor
WM05	Blue Tank Con. Fault				
WM03	Red Inline Con. Fault				
WM01	Blue Inline Con. Fault				
WM02	Red Hose Con. Fault				
WM04	Blue Hose Con. Fault				
WM07	Red Chiller Con. Fault				
WM08	Blue Chiller Con. Fault				
WMA6	Red Blanket High Temp.	Tank blanket is above the defined high alarm limit	Alarm	Defective RTD	Replace RTD
WMB5	Blue Blanket High Temp.			Defective High Power Temperature Control Module	Replace High Power Temperature Control Module
				Loose connections	Tighten connections
WMC6	Red Tank Con. Fault	Unexpected current to relay 1	Alarm	Shorted module	If temperature is being affected by a zone that has been disabled, replace heat module
WMC5	Blue Tank Con. Fault				
WMC3	Red Inline Con. Fault				
WMC1	Blue Inline Con. Fault				
WMC2	Red Hose Con. Fault				
WMC4	Blue Hose Con. Fault				
WMC7	Red Chiller Con. Fault				
WMC8	Blue Chiller Con. Fault				
WMH1	Motor Controller Fault	A general fault has occurred within the MCM	Deviation	Internal hardware failure	Cycle power, if the error persists the MCM will need to be replaced
WSC0	Invalid Setpoint Request	The requested controlling value (pressure or flow) is outside the limits of the system	Deviation	System incorrectly setup	On the ADM go into the setup screens -> System-> and ensure that all pages have properly defined values
				Shot incorrectly defined	Redefine shot with control parameters within the limits of the system
	Invalid Gel Timer Definition	The shot that was entered for the gel timer is not a valid shot. This must be fixed before the gel timer will function properly	Deviation	Gel timer shot is below the minimum dispense amount or set for a invalid pressure/flow	Select a different shot or modify existing shot data
				The MCM has determined that the gel timer shot will not be able to be executed based parameters entered in the ADM	If you are certain that the shot is within parameters, try running the Learn Mode routine found in the setup screen Calibration. If the error persists, a gel shot with reduced control parameters is required.

Appendix E - System Events

Event Code and String	Triggers
REL00: System Powered On	The System was powered on.
REM00: System Powered Off	The System was powered off.
REB00: Stop Button Pressed	The Red stop button was pressed on the Advanced Display Module.
RECH0: Learn Mode Executed	A learn mode calibration was successfully completed.
RENN0: Automatic Cal. Performed	The system was successfully characterized with the Automatic calibration.
RECA1: Red Material SG Modified	The Red materials specific gravity was modified.
RECB2: Blue Material SG Modified	The Blue materials specific gravity was modified.
RENC1: Cal. Point 1 Weight Entered	A value for the first point in the three point calibration was entered.
RENC2: Cal. Point 2 Weight Entered	A value for the second point in the three point calibration was entered.
RENC4: Cal. Point 1 Weight Erased	The running average for point one of the three point calibration was erased.
RENC5: Cal. Point 2 Weight Erased	The running average for point two of the three point calibration was erased.
REND0: Ratio Check Dispense	A ratio check shot was dispensed from the ratio check calibration screen.
REA00: Disp. Occurred (Shot #)	A dispense has occurred of the given shot number.
REH00: Gel Timer Dispense	The gel timer expired and the system automatically took the gel shot.
RER01: Shot Count Reset	A counter from the shot counters maintenance page was erased
RER02: Seq. Position Count Reset	A counter from the sequence counters maintenance page was erased
RERA1: Red Material Volume Reset	The resettable totalizer for the Red material volume was reset to zero.
RERB1: Blue Material Volume Reset	The resettable totalizer for the Blue material volume was reset to zero.
RERA2: Red Material Weight Reset	The resettable totalizer for the Red material weight was reset to zero.
RERB2: Blue Material Weight Reset	The resettable totalizer for the Blue material weight was reset to zero.
RERA3: Red Cycle Count Reset	The resettable cycle counter for the Red pump was reset to zero.
RERB3: Blue Cycle Count Reset	The resettable cycle counter for the Blue pump was reset to zero.
REQU1: Settings Downloaded	The system settings were successfully transferred from the ADM to a USB drive.

Event Code and String	Triggers
REQU2: Settings Uploaded	The system settings file was successfully transferred from the USB drive to the ADM.
REQU3: Language Downloaded	The custom language file was successfully transferred from the ADM to a USB drive.
REQU4: Language Uploaded	The custom language file was successfully transferred from the USB drive to the ADM.
REQU5: Logs Downloaded	The Error/Event and Shot data logs were successfully transferred from the ADM to a USB drive.
REAR0: Night Mode Recirc On	While in night mode the system has automatically entered a low recirculation mode and attempted to turn on all enabled conditioning zones.
REBR0: Night Mode Recirc Off	While in night mode the system has automatically stopped the low recirculation mode and turned off all conditioning zones.

Appendix F - USB Operation

Overview

There are 3 main uses for the USB on a GMS™ system

- Ability to download a log of up to the past 50,000 errors, events, or jobs that can contain over 150,000 snapshots of critical dispense information.
- Ability to download, modify, and upload custom language files
- Ability to download and upload system configurations
 - This data includes most user selectable and user configurable settings.
 - This data does not include pump counters, error and event logs, shot and sequence counters

USB Options

The only options for USB on the ADM are in **Advanced Screen 4**, see page 81.

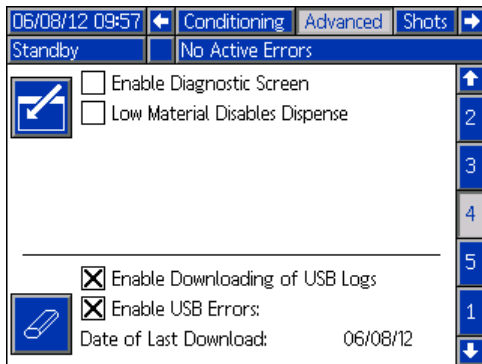

The first option is a checkbox that enables or disables the downloading of the Error Event and Shot Data log files. The Shot Data log runs during all recirculation, shots, and operator modes.

The second option is the Erase icon which will reset the last download date to a time where all logs can be downloaded. This will allow the user to download all the USB log entries, which may take over 2 hours if the log files are full. Currently the ADM does not monitor the USB logs and alert the user when data may be overwritten so in order to minimize download times and the risk of losing data it is recommended that the user download the logs every 2 weeks or more often if the machine is used during more than one full shift a day.

Download Log Files

If the “Enable Downloading of USB Logs” is checked, the user can use a USB stick-drive to download the log files.

NOTICE
<p>Low-quality USB stick drives may lead to burning out the USB port on the ADM. Use only high-quality USB stick-drives with the ADM USB port.</p>

To download the log files, insert a high-quality USB stick-drive into the USB port in the bottom of the ADM. The ADM will automatically begin downloading the log files as well as the custom language file (DISP-TEXT.TXT) and the system settings (SETTINGS.TXT). The status of the download will be shown in the Status bar.

Log Files, Folder Structure

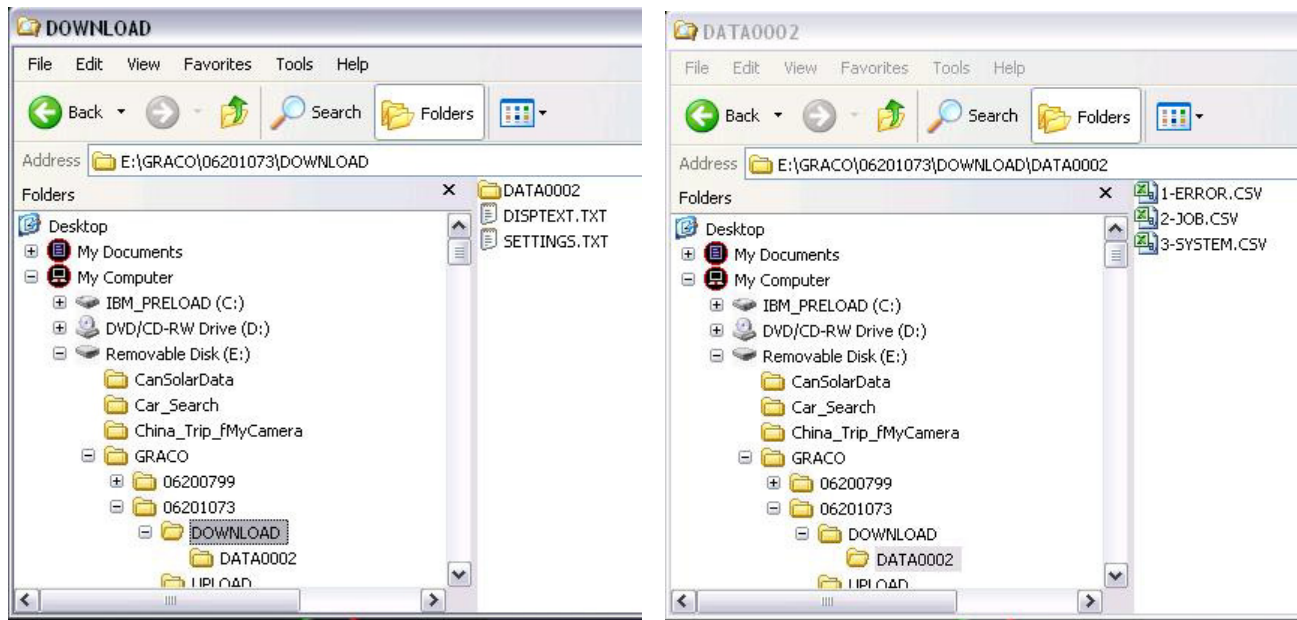

FIG. 24: DOWNLOAD, DATAxxxx Folders

Each time a stick-drive is inserted into the ADM USB port, a new folder named DATAxxxx is created. The number at the end of the folder name is incremented each time a stick-drive is inserted and data is downloaded or uploaded. In each DATAxxxx folder there is three log files. They are formatted as .csv (comma separated value) files and can be opened by most text editors or data processing programs such as Excel.

Example 1-ERROR File

The 1-ERROR file is the Errors and Events log file.

	A	B	C	D	E	F	G
1	Error Log						
2	S/N: 06201073						
3	Software Part Number: 16N420						
4	Software Version: 1.01.002						
5	4/23/2012 11:09						
6							
7	Date	Time	Error Log	Event Log		Active Shot Number	
8	4/11/2012	14:12:17	No Active Errors	EC0X-R:Setup Values Changed		-	
9	4/11/2012	14:13:26	No Active Errors	EC0X-R:Setup Values Changed		-	
10	4/11/2012	14:14:14	No Active Errors	EC0X-R:Setup Values Changed		-	
11	4/11/2012	14:15:00	No Active Errors	EC0X-R:Setup Values Changed		-	
12	4/11/2012	14:17:11	P4D0-A: Pressure Imbalance	No Event		-	
13	4/11/2012	14:17:17	Error Cleared: P4D0-A: Pressure Imbalance	No Event		-	
14	4/11/2012	14:17:31	DDA1-D: Red Pump Cavitation	No Event		-	
15	4/11/2012	14:17:44	DDB2-D: Blue Pump Cavitation	No Event		-	
16	4/11/2012	14:20:18	Error Cleared: DDA1-D: Red Pump Cavitation	No Event		-	
17	4/11/2012	14:20:18	Error Cleared: DDB2-D: Blue Pump Cavitation	No Event		-	
18	4/11/2012	14:20:46	P4D0-A: Pressure Imbalance	No Event		-	
19	4/11/2012	14:20:52	Error Cleared: P4D0-A: Pressure Imbalance	No Event		-	
20	4/11/2012	14:23:59	No Active Errors	EM00-R: System Powered Off		-	
21	4/11/2012	14:24:00	No Active Errors	EL00-R: System Powered On		-	
22	4/11/2012	14:48:47	No Active Errors	EM00-R: System Powered Off		-	
23	4/11/2012	14:48:48	No Active Errors	EL00-R: System Powered On		-	
24	4/11/2012	14:50:03	No Active Errors	EM00-R: System Powered Off		-	
25	4/11/2012	14:50:10	No Active Errors	EL00-R: System Powered On		-	
26	4/11/2012	14:50:18	No Active Errors	EM00-R: System Powered Off		-	
27	4/12/2012	7:51:33	No Active Errors	EL00-R: System Powered On		-	
28	4/12/2012	7:52:35	DDA1-D: Red Pump Cavitation	No Event		-	
29	4/12/2012	7:52:39	DDR2-D: Blue Pump Cavitation	No Event		-	

Example 2-JOB File

The 2-JOB file is the Shot Data Log file.

	A	B	C	D	E	F	G	H	I	J	
1	Job Log										
2	S/N: 06201073										
3	Software Part Number: 16N420										
4	Software Version: 1.01.002										
5	4/23/2012 11:09										
6											
7	Date	Time	Inline Blue RTD Temp	Requested Inline Blue Temp	Hose Blue FTS Temp	Requested Hose Blue Temp	Inline Red RTD Temp	Requested Inline Red Temp	Hose Red Temp	Requested Hose Red Temp	Tar Ma Ter
8	4/11/2012	14:16:52	-		-				-		
9	4/11/2012	14:16:54	-		-				-		
10	4/11/2012	14:16:56	-		-				-		
11	4/11/2012	14:16:58	-		-				-		
12	4/11/2012	14:17:00	-		-				-		
13	4/11/2012	14:17:02	-		-				-		
14	4/11/2012	14:17:04	-		-				-		
15	4/11/2012	14:17:07	-		-				-		
16	4/11/2012	14:17:09	-		-				-		
17	4/11/2012	14:17:11	-		-				-		
18	4/11/2012	14:17:28	-		-				-		

Example 3-SYSTEM File

The 3-SYSTEM file is the Software Version log file.

	A	B	C	D	E	F	G	H
1	System Software Log							
2	S/N: 06201073							
3	Software Part Number: 16N420							
4	Software Version: 1.01.002							
5	4/23/2012 11:11							
6								
7	Date	Time	Node:	Software Version				
8		4/23/2012	6:53:49	MCM Application Blue	1.01.108			
9		4/23/2012	6:53:49	MCM Component Blue	1.09.001			
10		4/23/2012	6:53:49	Blue Tank Monitor	1.01.001			
11		4/23/2012	6:53:49	Red Primary Heat	1.05.008			
12		4/23/2012	6:53:49	Blue Hose Heat	1.05.008			
13		4/23/2012	6:53:49	USB Configuration	1.07.001			
14		4/23/2012	6:53:49	Advanced Display	1.01.003			
15		4/23/2012	6:53:50	Blue Primary Heat	1.05.008			
16		4/23/2012	6:53:51	Red Hose Heat	1.05.008			
17		4/23/2012	6:53:54	Red Primary Heat	1.05.008			
18		4/23/2012	6:53:56	Blue Primary Heat	1.05.008			
19								
20								
21								

Transfer System Settings

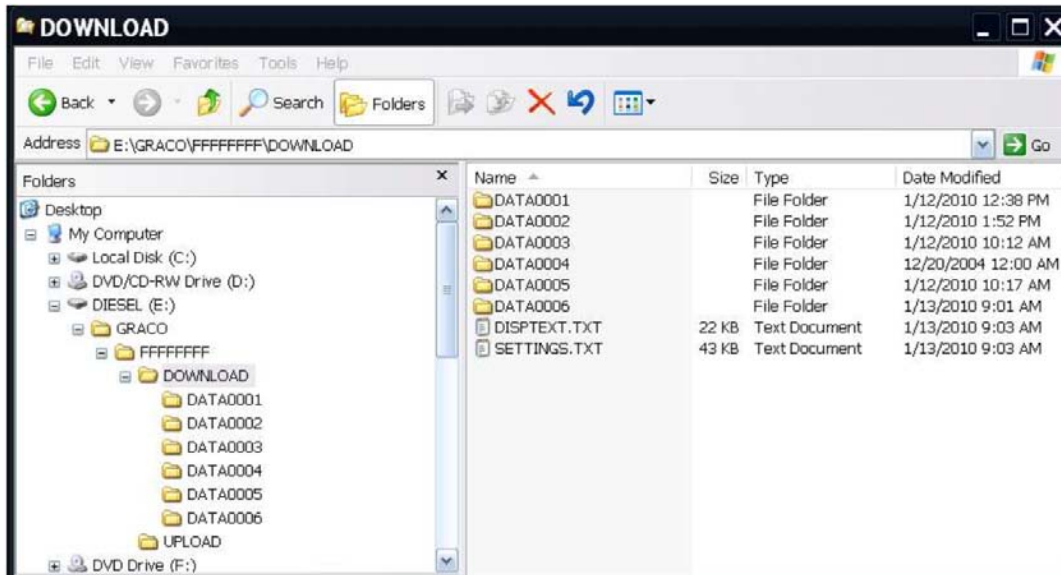

NOTICE

Low-quality USB stick drives may lead to burning out the USB port on the ADM. Use only high-quality USB stick-drives with the ADM USB port.

Use the following process to transfer system settings from one machine to another.

1. Insert a high-quality USB stick-drive into the USB port on the system with the settings to be transferred. Once the download is complete the SETTINGS.TXT file will be located in the "DOWNLOAD" folder.

NOTICE

The user should never attempt to modify the SETTINGS.TXT file in any way. Graco is not responsible for damages caused by an improperly modified setup file.

2. Plug the USB stick-drive into a computer.
3. Navigate to the DOWNLOAD folder.
4. Copy the SETTINGS.TXT file from the DOWNLOAD folder into the UPLOAD folder.
5. Remove the USB stick-drive from the computer and install it into the ADM USB port for the second machine. The software will automatically begin updating.

NOTE: Before the update begins the ADM automatically shuts down the system, aborting any in-progress dispensing. When the software is updating the system a pop-up box will appear to inform the user of the update and the system will lock. Once the update is complete the ADM will tell the user to cycle power to apply the updates. Once this box appears it is safe to remove the drive before cycling power.

6. When the software is done updating, remove the USB stick-drive from the ADM USB port and install in a computer.
7. Navigate to the UPLOAD folder and remove the SETTINGS.TXT file.

NOTE: Immediately after uploading the settings, remove the SETTINGS.TXT file from the UPLOAD folder to prevent accidental loss of data the next time the USB stick-drive is inserted into the ADM USB port. If there is a SETTINGS.TXT file in the UPLOAD folder when the USB stick-drive is inserted into the ADM USB port the software will try to update the ADM.

Update Custom Language

NOTICE

Low-quality USB stick drives may lead to burning out the USB port on the ADM. Use only high-quality USB stick-drives with the ADM USB port.

Use the following process to customize the text on the ADM. The language file DISPTTEXT.TXT can be modified in Excel but must be saved as a Unicode Text file with the extension .TXT in order for it to properly import.

1. Insert a high-quality USB stick-drive into the USB port on the system with the settings to be transferred. Once the download is complete the DISPTTEXT.TXT file will be located in the "DOWNLOAD" folder.
2. Plug the USB stick-drive into a computer.
3. Navigate to the DOWNLOAD folder.
4. Copy the DISPTTEXT.TXT file from the DOWNLOAD to your computer.
5. Use any data processing software such as Excel to edit the DISPTTEXT.TXT file. When done editing save the file as the "Unicode Text" format. See **Example DISPTTEXT.TXT File** on page 107.
 - a. In the first column, locate the string to change.
 - b. In the second column of the same row, enter the new string.
 - c. Save the file as a Unicode Text file. The name must remain "DISPTTEXT.TXT".
6. Copy the edited DISPTTEXT.TXT file into the UPLOAD folder.
7. Remove the USB stick-drive from the computer and install it into the ADM USB port. The software will automatically begin updating.

NOTE: Before the update begins the ADM automatically shuts down the system, aborting any in-progress dispensing. When the software is updating the system a pop-up box will appear to inform the user of the update and the system will lock. Once the update is complete the ADM will tell the user to cycle power to apply the updates. Once this box appears it is safe to remove the drive before cycling power.

8. When the software is done updating, remove the USB stick-drive from the ADM USB port and install in a computer.
9. Navigate to the UPLOAD folder and remove the DISPTTEXT.TXT file.

NOTE: Immediately following uploading the language file, remove the DISPTTEXT.TXT file from the UPLOAD folder to prevent accidental loss of data the next time the USB stick-drive is inserted into the ADM USB port. If there is a DISPTTEXT.TXT file in the UPLOAD folder when the USB stick-drive is inserted into the ADM USB port the software will try to update the ADM.

Example SETTINGS.TXT File

NOTICE

The user should never attempt to modify the SETTINGS.TXT file in any way. Graco is not responsible for damages caused by an improperly modified setup file.

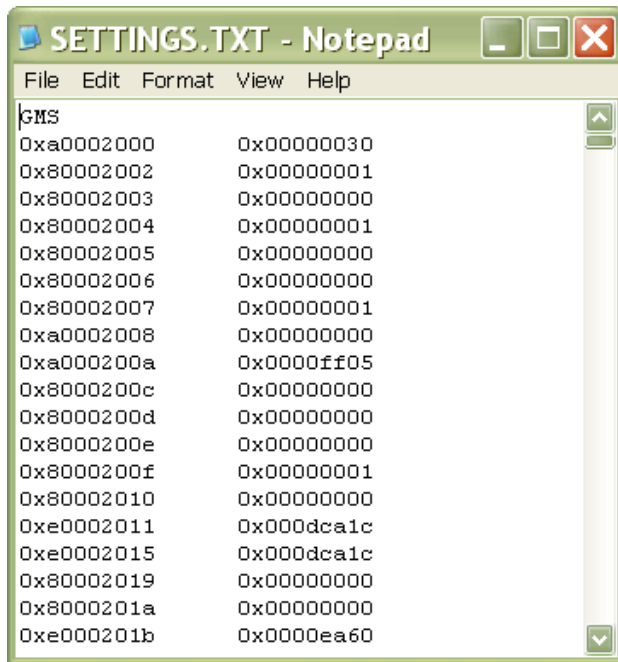

Example DISPTEXT.TXT File

	A	B	C	D
1	English	Custom		
2				
3	1			
4	2			
5	3			
6	4			
7	10			
8	15			
9	20			
10	25			
11	30			
12	40			
13	50			
14	60			
15	80			
16	100			
17	120			
18	145			
19	160			
20	180			

Technical Data

Maximum Fluid Working Pressure . . .	3000 psi (20.7 MPa, 207 bar)
Maximum Fluid Temperature	190°F (88°C)
Fluid Inlet Feed Pressure Range	50 psi (0.35 MPa, 3.5 bar) to 250 psi (1.75 MPa, 17.5 bar)
Fluid Inlets	<i>Component A (Red):</i> 1/2 npt(f) <i>Component B (Blue):</i> 3/4 npt(f)
Fluid Outlets.	<i>Component A (Red):</i> #8 (1/2 in.) JIC (3/4-16 unf), with #5 (5/16 in.) JIC adapter <i>Component B (Blue):</i> #10 (5/8 in.) JIC (7/8-14 unf), with #6 (3/8 in.) JIC adapter
Fluid Circulation Ports	1/4 npsm(m), with plastic tubing, 250 psi (1.75 MPa, 17.5 bar) maximum
Line Voltage Requirement	<i>230V / 1 phase and 230V / 3 phase Models:</i> 195-264V, 50/60 Hz <i>400V / 3 phase:</i> 360-440V, 50/60 Hz
Amperage Requirement.	See Models on page 4
Sound Power	93 dB
Heater Power (A (Red) and B (Blue) heaters total, no hose, Heated HFR Models only). . .	12 kW
Hydraulic reservoir capacity.	9 gal. (34 liters)
Recommended hydraulic fluid	Citgo A/W Hydraulic Oil, ISO Grade 46
Weight	<i>Units with 12 kW Heaters:</i> 868 lb (394 kg) <i>Units without heaters:</i> 634 lb (288 kg)
Wetted Parts	Aluminum, stainless steel, zinc-plated carbon steel, brass, carbide, chrome, fluoroelastomer, PTFE, ultra-high molecular weight polyethylene, chemically resistant o-rings

All other brand names or marks are used for identification purposes and are trademarks of their respective owners.

Motor Control Module Technical Data

Input Specifications

Input Line Voltage	0-264 Vac, line-to-line
Input Line Phasing	Single or Three Phase
Input Line Frequency	50/60 Hz
Input Current per Phase.	25A (three-phase), 50A (single-phase)
Maximum Branch Circuit Protection Rating:	30A (three-phase), 63A (single-phase)
Short Circuit Current Rating.	5 kA

Output Specifications

Output Line Voltage	0-264 Vac
Output Line Phasing	Three Phase
Output Current	0-30A
Output Overload.	200% for 0.2 seconds

DC Power Supply	24 Vdc, Class 2, Graco-provided power supply
Enclosure	Type 1
Max Ambient Temperature	50°C (122°F)

Overtemperature protection is provided to protect from motor overload.

Current limit, set via the software, is provided as a secondary protection from motor overload.

All installations and wiring must comply with NEC and local electrical codes.

Dimensions

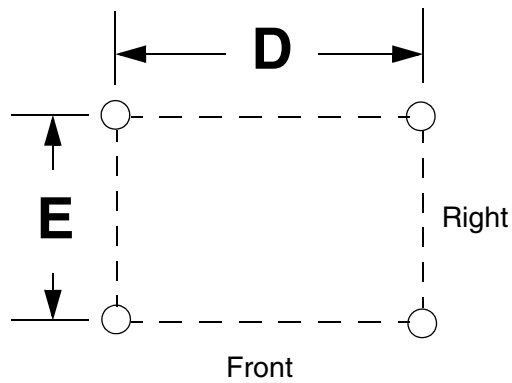
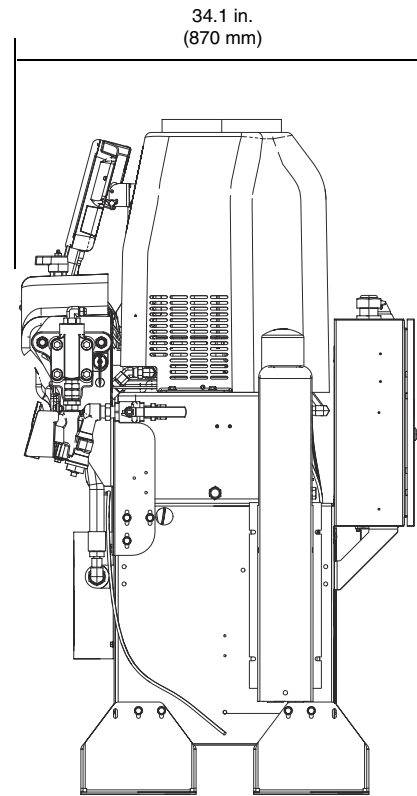
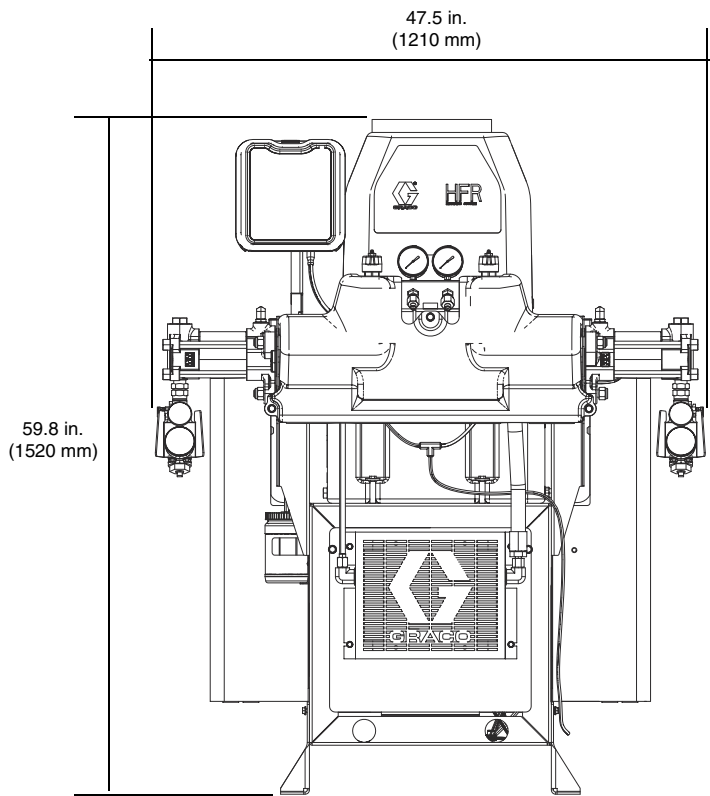

Bolt Mounting Pattern and Dimensions

Ref	Type of Base	
	No Pallet	Pallet
D	24 in. (610 mm)	32.4 in. (823 mm)
E	15 in. (381 mm)	30.3 in. (770 mm)

Graco Standard Warranty

Graco warrants all equipment referenced in this document which is manufactured by Graco and bearing its name to be free from defects in material and workmanship on the date of sale to the original purchaser for use. With the exception of any special, extended, or limited warranty published by Graco, Graco will, for a period of twelve months from the date of sale, repair or replace any part of the equipment determined by Graco to be defective. This warranty applies only when the equipment is installed, operated and maintained in accordance with Graco's written recommendations.

This warranty does not cover, and Graco shall not be liable for general wear and tear, or any malfunction, damage or wear caused by faulty installation, misapplication, abrasion, corrosion, inadequate or improper maintenance, negligence, accident, tampering, or substitution of non-Graco component parts. Nor shall Graco be liable for malfunction, damage or wear caused by the incompatibility of Graco equipment with structures, accessories, equipment or materials not supplied by Graco, or the improper design, manufacture, installation, operation or maintenance of structures, accessories, equipment or materials not supplied by Graco.

This warranty is conditioned upon the prepaid return of the equipment claimed to be defective to an authorized Graco distributor for verification of the claimed defect. If the claimed defect is verified, Graco will repair or replace free of charge any defective parts. The equipment will be returned to the original purchaser transportation prepaid. If inspection of the equipment does not disclose any defect in material or workmanship, repairs will be made at a reasonable charge, which charges may include the costs of parts, labor, and transportation.

THIS WARRANTY IS EXCLUSIVE, AND IS IN LIEU OF ANY OTHER WARRANTIES, EXPRESS OR IMPLIED, INCLUDING BUT NOT LIMITED TO WARRANTY OF MERCHANTABILITY OR WARRANTY OF FITNESS FOR A PARTICULAR PURPOSE.

Graco's sole obligation and buyer's sole remedy for any breach of warranty shall be as set forth above. The buyer agrees that no other remedy (including, but not limited to, incidental or consequential damages for lost profits, lost sales, injury to person or property, or any other incidental or consequential loss) shall be available. Any action for breach of warranty must be brought within two (2) years of the date of sale.

GRACO MAKES NO WARRANTY, AND DISCLAIMS ALL IMPLIED WARRANTIES OF MERCHANTABILITY AND FITNESS FOR A PARTICULAR PURPOSE, IN CONNECTION WITH ACCESSORIES, EQUIPMENT, MATERIALS OR COMPONENTS SOLD BUT NOT MANUFACTURED BY GRACO. These items sold, but not manufactured by Graco (such as electric motors, switches, hose, etc.), are subject to the warranty, if any, of their manufacturer. Graco will provide purchaser with reasonable assistance in making any claim for breach of these warranties.

In no event will Graco be liable for indirect, incidental, special or consequential damages resulting from Graco supplying equipment hereunder, or the furnishing, performance, or use of any products or other goods sold hereto, whether due to a breach of contract, breach of warranty, the negligence of Graco, or otherwise.

FOR GRACO CANADA CUSTOMERS

The Parties acknowledge that they have required that the present document, as well as all documents, notices and legal proceedings entered into, given or instituted pursuant hereto or relating directly or indirectly hereto, be drawn up in English. Les parties reconnaissent avoir convenu que la rédaction du présente document sera en Anglais, ainsi que tous documents, avis et procédures judiciaires exécutés, donnés ou intentés, à la suite de ou en rapport, directement ou indirectement, avec les procédures concernées.

Graco Information

For the latest information about Graco products, visit www.graco.com.

TO PLACE AN ORDER, contact your Graco distributor or call to identify the nearest distributor.

Phone: 612-623-6921 **or Toll Free:** 1-800-328-0211 **Fax:** 612-378-3505

All written and visual data contained in this document reflects the latest product information available at the time of publication. Graco reserves the right to make changes at any time without notice.

For patent information, see www.graco.com/patents.

Original instructions. This manual contains English. MM 313997

Graco Headquarters: Minneapolis

International Offices: Belgium, China, Japan, Korea

GRACO INC. AND SUBSIDIARIES • P.O. BOX 1441 • MINNEAPOLIS MN 55440-1441 • USA

Copyright 2010, Graco Inc. All Graco manufacturing locations are registered to ISO 9001.

www.graco.com

Revised November 2012